

The Evolution of *The Back Page*



April 1990 saw the launch of the Hubble Telescope; an earthquake in Shropshire measuring 5.1 on the Richter scale (probably not connected); and the first appearance of an unassuming half-page advert on an inside page of *The Chronicle*.

FLACKWELL ELECTRONICS

TELEVISION, VIDEO AND
SATELLITE SERVICING

In the home, most makes

DAVID LEWIS
Church Farm
Aston Abbotts

Tel. Aylesbury 682126

It was well before the first commercial flat screen television had hit the market and the battle of formats between VHS and Betamax video tapes was in its final throes. The unreliability of the high voltage components used in cathode ray televisions along with the mechanical intricacies of video tape recorders created fertile feeding grounds for many enterprising electronic repair boffins.

And it was one such enterprising chap, a Mr Dave Lewis of Aston Abbotts, who provided such a TV and Video repair service and who was responsible for the appearance of the advert.

Evidently business was going reasonably well and, in February 1991, the half-page adverts began to make a regular appearance on the premium advertising space that was the rear cover of *The Chronicle*.



It was the November 1996 issue of *The Chronicle* that saw a change in the adverts that would eventually evolve into what became known colloquially as *The Back Page*. This was the insertion into the half-page adverts of a small cartoon or other witticism.

As the months passed, it appears that Dave's fortunes improved further and, in October 1998, he started to place full-page adverts. These adverts remained mostly dedicated to advertising Dave's business, but a small space continued to be used for the ever-changing cartoons and jokes.

Many more months passed and it was in 2002 that *The Back Page* evolved into its final form with the "humour element" of the advert often dominating *The Back Page* – a notable example being the *Aston Abbotts Watchtower* which appeared in fifteen *Chronicles* between January 2014 and June 2015.

Playgirl

THE SENIOR ISSUE!

NOVEMBER PLAYMATE
DAVID W. LEWIS

WATCHTOWER

ASTON ABBOTTS

New Aston Abbotts Men's Opens
The new Aston Abbotts Men's Opens...
Ask Anita From
The new Aston Abbotts Men's Opens...
John Wayne Has a Look
The new Aston Abbotts Men's Opens...
Essex Fathers
The new Aston Abbotts Men's Opens...
Christmas Disappointment
The new Aston Abbotts Men's Opens...
Perilous Observed
The new Aston Abbotts Men's Opens...
Mr and Mrs Whyte Do Not Drink Off!
The new Aston Abbotts Men's Opens...

The final *The Back Page* appeared in November 2016 followed by a full-page New Year's Greeting from Dave in the December issue. Apart from a brief hiatus from April to September 2009, and the odd time when the rear cover was used to announce an important village event, *The Back Page* was always a source of great amusement. This whole venture resulted in a total of 210 *The Back Page* version of the adverts being published – all of which are reprinted here.

And the postscript to all of this is that Dave had no say in what went on The Back Page. It was the editors who were the authors of the jokes which were often based cryptically around some event or minor misdemeanour in Dave's life!

Alison J Whittaker, B.A. Hons. Music
*Piano, Electric Keyboard &
Theory of Music Teacher*

10 Recreation Ground Cottages
Wingrave,
Nr. Aylesbury
Bucks. HP22 4PH Tel; (01296)

BIGNELL & BRANDON

*Carpentry, Glazing,
General Building and Maintenance*

Aylesbury 681242 Aylesbury
432390

ASTON ABBOTTS CHURCH ROOM

AVAILABLE FOR WEDDING RECEPTIONS: BIRTHDAY
PARTIES: FOLK EVENINGS: DANCES: BINGO ETC...

MAXIMUM 60 PEOPLE.

FURTHER DETAIL FROM DORIS SCUTCHINGS ON

AYLESBURY (01296) 681 243

Cost;- £5.00 per hour + metered electricity
£2.00 per hour + metered electricity for residents of the parish

FLACKWELL ELECTRONICS

Church Farm, Aston Abbots

TV. VIDEO & SATELLITE SERVICING

General Repairs

(MOST MAKES REPAIRED THE SAME DAY)

Rentals, New and Used Sales

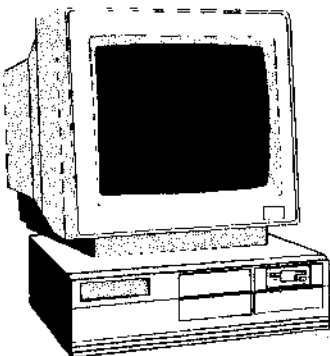

No call out fee within Aston Abbots
Phone David Lewis 682126

*P.S. This is meant to be a
television and video.
Ed.*

Alison J Whittaker, B.A. Hons. Music
*Piano, Electric Keyboard &
Theory of Music Teacher*

10 Recreation Ground Cottages
Wingrave,
Nr. Aylesbury
Bucks. HP22 4PH Tel: (01296)

BIGNELL & BRANDON

*Carpentry, Glazing,
General Building and Maintenance*

Aylesbury 681242 Aylesbury
432390

**ASTON ABBOTTS
CHURCH ROOM**

AVAILABLE FOR WEDDING RECEPTIONS: BIRTHDAY
PARTIES: FOLK EVENINGS: DANCES: BINGO ETC...

MAXIMUM 60 PEOPLE.

FURTHER DETAIL FROM DORIS SCUTCHINGS ON

AYLESBURY (01296) 681 243

Cost:- £5.00 per hour + metered electricity
£2.00 per hour + metered electricity for residents of the parish

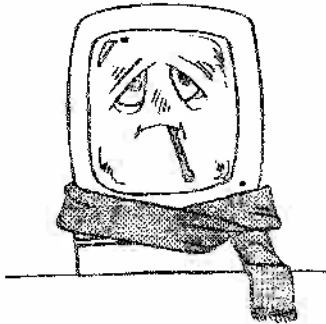

**FLACKWELL
ELECTRONICS**

Church Farm, Aston Abbots

**TV. VIDEO & SATELLITE
SERVICING**

General Repairs

(MOST MAKES REPAIRED THE SAME DAY)

Rentals, New and Used Sales

*Is your 'Telly' feeling under par and not
looking forward to the forthcoming festivities?
Are you in danger of missing out on clearly
videoing some of those marvellous programmes
'Aunty' is putting on this Christmas?*

Then;- Phone David Lewis 682126
No call out fee within Aston Abbots

Alison J Whittaker, B.A. Hons. Music
*Piano, Electric Keyboard &
Theory of Music Teacher*

10 Recreation Ground Cottages
Wingrave,
Nr. Aylesbury
Bucks. HP22 4PH Tel: (01296)

BIGNELL & BRANDON

*Carpentry, Glazing,
General Building and Maintenance*

Aylesbury 681242 Aylesbury
432390

ASTON ABBOTTS CHURCH ROOM

AVAILABLE FOR WEDDING RECEPTIONS: BIRTHDAY
PARTIES: FOLK EVENINGS: DANCES: BINGO ETC...

MAXIMUM 60 PEOPLE.

FURTHER DETAIL FROM DORIS SCUTCHINGS ON

AYLESBURY (01296) 681 243

Cost:- £5.00 per hour + metered electricity
£2.00 per hour + metered electricity for residents of the parish

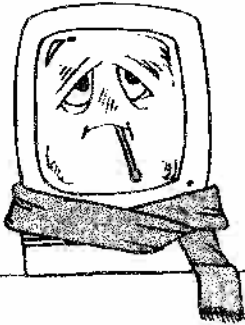

FLACKWELL ELECTRONICS

Church Farm, Aston Abbots

**TV. VIDEO & SATELLITE
SERVICING**

General Repairs

(MOST MAKES REPAIRED THE SAME DAY)

Rentals, New and Used Sales

*Does your Telly seem out of focus? Does the sound
always appear too loud and a little distorted? - You've probably
got a hangover after all the festivities!!*

Never mind;- Phone David Lewis on 682126 (He's got one too)

*There's still no call out fee within Aston Abbots
(especially if you ask him round for a little 'hair of the dog').*

Back page

Chron ads

Alison J Whittaker, B.A. Hons. Music
*Piano, Electric Keyboard &
Theory of Music Teacher*

10 Recreation Ground Cottages
Wingrave,
Nr. Aylesbury
Bucks. HP22 4PH Tel: (01296)

BIGNELL & BRANDON

*Carpentry, Glazing,
General Building and Maintenance*

Aylesbury
681242

ASTON ABBOTTS

CHURCH ROOM

AVAILABLE FOR WEDDING RECEPTIONS: BIRTHDAY
PARTIES: FOLK EVENINGS: DANCES: BINGO ETC...

MAXIMUM 60 PEOPLE.

FURTHER DETAIL FROM DORIS SCUTCHINGS ON

AYLESBURY (01296) 681 243

Cost:- £5.00 per hour + metered electricity
£2.00 per hour + metered electricity for residents of the parish

**CUSTOMERS
PLEASE NOTE!!**



*Owing to a substantial win on
the Lottery, no further repair
work will be accepted until at
least the 5th of February.*

FLACKWELL ELECTRONICS

Church Farm, Aston Abbotts

**TV. VIDEO & SATELLITE
SERVICING**
General Repairs
(MOST MAKES REPAIRED THE SAME DAY)
Rentals, New and Used Sales
No call out fee within Aston Abbotts

*For details of this highly successful
and winning system please :-*

Phone David Lewis on 682126

(No begging letters please!!)

Back page

Chron ads

Alison J Whittaker, B.A. Hons. Music
*Piano, Electric Keyboard &
Theory of Music Teacher*

10 Recreation Ground Cottages
Wingrave,
Nr. Aylesbury
Bucks. HP22 4PH Tel: (01296)

BIGNELL & BRANDON

*Carpentry, Glazing,
General Building and Maintenance*

Aylesbury
681242

ASTON ABBOTTS

CHURCH ROOM

AVAILABLE FOR WEDDING RECEPTIONS: BIRTHDAY
PARTIES: FOLK EVENINGS: DANCES: BINGO ETC...

MAXIMUM 60 PEOPLE.

FURTHER DETAIL FROM DORIS SCUTCHINGS ON

AYLESBURY (01296) 681 243

Cost:- £5.00 per hour + metered electricity
£2.00 per hour + metered electricity for residents of the parish

Fed-up with slow
delivery of your
repaired television or
video?

Try us. Not only do
we offer you a fast
repair but should
you require it, we are
able to deliver by
helicopter.

FLACKWELL ELECTRONICS

Church Farm, Aston Abbots

**TV. VIDEO & SATELLITE
SERVICING**

General Repairs

(MOST MAKES REPAIRED THE SAME DAY)

Rentals, New and Used Sales

No call out fee within Aston Abbots

Phone David Lewis on 682126 for details.



Alison J Whittaker, B.A. Hons. Music

*Piano, Electric Keyboard &
Theory of Music Teacher*

10 Recreation Ground Cottages
Wingrave,
Nr. Aylesbury
Bucks. HP22 4PH Tel; (01296) 681639

BIGNELL & BRANDON

*Carpentry, Glazing,
General Building and Maintenance*

Aylesbury 681242 Aylesbury 432390
Mobile 0468 115527 Mobile 0468 126612

ASTON ABBOTTS CHURCH ROOM

AVAILABLE FOR WEDDING RECEPTIONS: BIRTHDAY
PARTIES: FOLK EVENINGS: DANCES: BINGO ETC...

MAXIMUM 60 PEOPLE.

FURTHER DETAIL FROM DORIS SCUTCHINGS ON

AYLESBURY (01296) 681 243

Cost;- £5.00 per hour + metered electricity
£2.00 per hour + metered electricity for residents of the parish

*At wits end to spend
huge lottery win. Since
much of it has already
been invested in The Bull
& Butcher, we are
currently negotiating a
'buy-out'. Would
customers please note
that if not on my usual
number, I can usually be
found in The 'Bull'.
(Negotiating of course!!)*



FLACKWELL ELECTRONICS

Church Farm, Aston Abbots

**TV. VIDEO & SATELLITE
SERVICING**

General Repairs

(MOST MAKES REPAIRED THE SAME DAY)

Rentals, New and Used Sales

No call out fee within Aston Abbots

Phone David Lewis on 682126 for details.

Back page

Chron ads

Alison J Whittaker, B.A. Hons. Music

*Piano, Electric Keyboard &
Theory of Music Teacher*

10 Recreation Ground Cottages
Wingrave,
Nr. Aylesbury
Bucks. HP22 4PH Tel; (01296) 681639

BIGNELL & BRANDON

*Carpentry, Glazing,
General Building and Maintenance*

Aylesbury 681242 Aylesbury 432390
Mobile 0468 115527 Mobile 0468 126612

ASTON ABBOTTS

CHURCH ROOM

**AVAILABLE FOR WEDDING RECEPTIONS: BIRTHDAY
PARTIES: FOLK EVENINGS: DANCES: BINGO ETC...**

MAXIMUM 60 PEOPLE.

FURTHER DETAIL FROM DORIS SCUTCHINGS ON

AYLESBURY (01296) 681 243

**Cost:- £5.00 per hour + metered electricity
£2.00 per hour + metered electricity for residents of the parish**

*Negotiations for The Bull &
Butcher are definitely on hold
owing to hooligan element
who cut the trouser leg off my
best jeans while I was having a
'quiet' drink. Also, couldn't
help noticing a number of
customers leaving sans hair.
We're used to a pint costing an
arm & a leg but this is
ridiculous. Anyone requiring
TV repairs out of hours will
find me in The Royal Oak
henceforth.*



FLACKWELL ELECTRONICS

Church Farm, Aston Abbots

**TV. VIDEO & SATELLITE
SERVICING**

General Repairs

(MOST MAKES REPAIRED THE SAME DAY)

Rentals, New and Used Sales

No call out fee within Aston Abbots

Phone David Lewis on 682126 for details.

Back page

Chron ads

Alison J Whittaker, B.A. Hons. Music

*Piano, Electric Keyboard &
Theory of Music Teacher*

10 Recreation Ground Cottages
Wingrave,
Nr. Aylesbury
Bucks. HP22 4PH Tel; (01296) 681639

BIGNELL & BRANDON

*Carpentry, Glazing,
General Building and Maintenance*

Aylesbury 681242 Aylesbury 432390
Mobile 0468 115527 Mobile 0468 126612

**ASTON ABBOTTS
CHURCH ROOM**

AVAILABLE FOR WEDDING RECEPTIONS: BIRTHDAY
PARTIES: FOLK EVENINGS: DANCES: BINGO ETC...

MAXIMUM 60 PEOPLE.

FURTHER DETAIL FROM DORIS SCUTCHINGS ON

AYLESBURY (01296) 681 243

Cost;- £5.00 per hour + metered electricity
£2.00 per hour + metered electricity for residents of the parish

*As a direct result of Tom Manning
having been elected Chairman of the Parish
Council, negotiations for the purchase of
the The Bull & Butcher have been
reinstated with Tom as my new partner. Not
that should we be successful in our
negotiations I would anticipate special
treatment from the Parish Council ; it's just
that I value his expertise as a dedicated and
knowledgeable exponent of Bacchanalian
philosophies and principals!!*



**FLACKWELL
ELECTRONICS**

Church Farm, Aston Abbots

**TV. VIDEO & SATELLITE
SERVICING**

General Repairs

(MOST MAKES REPAIRED THE SAME DAY)

Rentals, New and Used Sales

No call out fee within Aston Abbots

Phone David Lewis on 682126 for details.

Alison J Whittaker, B.A. Hons. Music

*Piano, Electric Keyboard &
Theory of Music Teacher*

10 Recreation Ground Cottages
Wingrave,
Nr. Aylesbury
Bucks. HP22 4PH Tel: (01296) 681639

BIGNELL & BRANDON

*Carpentry, Glazing,
General Building and Maintenance*

Aylesbury 681242 Aylesbury 432390

Mobile 0468 115527 Mobile 0468 126612

**ASTON ABBOTTS
CHURCH ROOM**

AVAILABLE FOR WEDDING RECEPTIONS: BIRTHDAY
PARTIES: FOLK EVENINGS: DANCES: BINGO ETC...

MAXIMUM 60 PEOPLE.

FURTHER DETAIL FROM DORIS SCUTCHINGS ON

AYLESBURY (01296) 681 243

Cost:- £5.00 per hour + metered electricity
£2.00 per hour + metered electricity for residents of the parish

*Here's wishing all
my readers a very
happy and peaceful
summer holiday.*



Dave Lewis

**FLACKWELL
ELECTRONICS**
Church Farm, Aston Abbots

**TV. VIDEO & SATELLITE
SERVICING**

General Repairs

(MOST MAKES REPAIRED THE SAME DAY)

Rentals, New and Used Sales

No call out fee within Aston Abbots

Phone David Lewis on 682126 for details.

Alison J Whittaker, B.A. Hons. Music

*Piano, Electric Keyboard &
Theory of Music Teacher*

10 Recreation Ground Cottages
Wingrave,
Nr. Aylesbury
Bucks. HP22 4PH Tel: (01296) 681639

BIGNELL & BRANDON

*Carpentry, Glazing,
General Building and Maintenance*

Aylesbury 681242 Aylesbury 432390
Mobile 0468 115527 Mobile 0468 126612

ASTON ABBOTTS

CHURCH ROOM

AVAILABLE FOR WEDDING RECEPTIONS: BIRTHDAY
PARTIES: FOLK EVENINGS: DANCES: BINGO ETC...

MAXIMUM 60 PEOPLE.

FURTHER DETAIL FROM DORIS SCUTCHINGS ON

AYLESBURY (01296) 681 243

Cost:- £5.00 per hour + metered electricity
£2.00 per hour + metered electricity for residents of the parish

*Had a really great holiday
and am now fit and ready for
anything - even work!!.*



FLACKWELL ELECTRONICS

Church Farm, Aston Abbots

**TV. VIDEO & SATELLITE
SERVICING**

General Repairs

(MOST MAKES REPAIRED THE SAME DAY)

Rentals, New and Used Sales

No call out fee within Aston Abbott

Phone David Lewis on 682126 for details.

Alison J Whitaker, B.A. Mons. Music

*Piano, Electric Keyboard &
Theory of Music Teacher*

16 Recreation Ground Cottages
Wingrave,
Nr. Aylesbury
Bucks. HP22 4FH Tel: (01296) 681639

BIGNELL & FRANKLIN

*Carpentry, Glazing,
General Building and Maintenance*

Aylesbury 681242 Aylesbury 432090

Mobile 0468 115527 Mobile 0468 126612

ASTON ABBOTTS

CHURCH ROOM

AVAILABLE FOR WEDDING RECEPTIONS: BIRTHDAY
PARTIES: FOLK EVENINGS: DANCES: BINGO ETC...

MAXIMUM 60 PEOPLE.

FURTHER DETAIL FROM DORIS SCOTCHINGS ON

AYLESBURY (01296) 681 243

Cost: £5.00 per hour + metered electricity
£2.00 per hour + metered electricity for residents of the parish

*Our fully trained and highly
motivated staff have at their
disposal the latest manuals
covering most makes of television
and video equipment.*

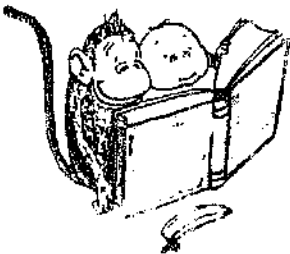

Dave Lewis (Managing Director)

FLACKWELL ELECTRONICS

Church Farm, Aston Abbots

**TV, VIDEO & SATELLITE
SERVICING**

General Repairs
(MOST MAKES REPAIRED THE SAME DAY)
Rentals, New and Used Sales

No call out fee within Aston Abbott

Phone David Lewis on 682126 for details.

Alison J Whittaker, B.A. Hons. Music

*Piano, Electric Keyboard &
Theory of Music Teacher*

10 Recreation Ground Cottages

Wingrave,

Nr. Aylesbury

Bucks. HP22 4PH

Tel: (01296) 681639

BIGNELL & BRANDON

*Carpentry, Glazing,
General Building and Maintenance*

Aylesbury 681242 Aylesbury 432390

Mobile 0468 115527 Mobile 0468 126612

ASTON ABBOTTS

CHURCH ROOM

AVAILABLE FOR WEDDING RECEPTIONS: BIRTHDAY
PARTIES: FOLK EVENINGS: DANCES: BINGO ETC...

MAXIMUM 60 PEOPLE.

FURTHER DETAIL FROM DORIS SCUTCHINGS ON

AYLESBURY (01296) 681 243

Cost:- £5.00 per hour + metered electricity

£2.00 per hour + metered electricity for residents of the parish

*Our fully trained and highly
motivated staff have at their
disposal the latest manuals
covering most makes of television
and video equipment.*

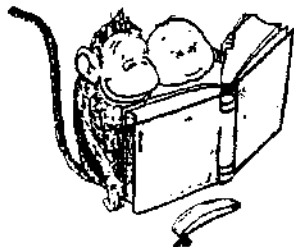

Dave Lewis (Managing Director)

FLACKWELL ELECTRONICS

Church Farm, Aston Abbots

**TV. VIDEO & SATELLITE
SERVICING**

General Repairs

(MOST MAKES REPAIRED THE SAME DAY)

Rentals, New and Used Sales

No call out fee within Aston Abbott

Phone David Lewis on 682126 for details.

Alison J Whittaker, B.A. Hons. Music

*Piano, Electric Keyboard &
Theory of Music Teacher*

10 Recreation Ground Cottages
Wingrave,
Nr. Aylesbury
Bucks. HP22 4PH Tel: (01296) 681639

BIGNELL & BRANDON

*Carpentry, Glazing,
General Building and Maintenance*

Aylesbury 681242 Aylesbury 432390
Mobile 0468 115527 Mobile 0468 126612

**ASTON ABBOTTS
CHURCH ROOM**

AVAILABLE FOR WEDDING RECEPTIONS: BIRTHDAY
PARTIES: FOLK EVENINGS: DANCES: BINGO ETC...

MAXIMUM 60 PEOPLE.

FURTHER DETAIL FROM DORIS SCUTCHINGS ON

AYLESBURY (01296) 681 243

Cost:- £5.00 per hour + metered electricity
£2.00 per hour + metered electricity for residents of the parish

*Our fully trained and highly
motivated staff have at their
disposal the latest manuals
covering most makes of television
and video equipment.*

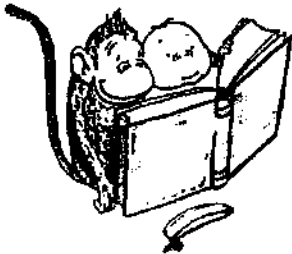

Dave Lewis (Managing Director)

**FLACKWELL
ELECTRONICS**
Church Farm, Aston Abbots

**TV. VIDEO & SATELLITE
SERVICING**

General Repairs
(MOST MAKES REPAIRED THE SAME DAY)
Rentals, New and Used Sales

No call out fee within Aston Abbott

Phone David Lewis on 682126 for details.

Alison J Whittaker, B.A. Hons. Music

*Piano, Electric Keyboard &
Theory of Music Teacher*

10 Recreation Ground Cottages
Wingrave,
Nr. Aylesbury
Bucks. HP22 4PH Tel; (01296) 681639

BIGNELL & BRANDON

*Carpentry, Glazing,
General Building and Maintenance*

Aylesbury 681242 Aylesbury 432390
Mobile 0468 115527 Mobile 0468 126612

ASTON ABBOTTS

CHURCH ROOM

**AVAILABLE FOR WEDDING RECEPTIONS: BIRTHDAY
PARTIES: FOLK EVENINGS: DANCES: BINGO ETC...**

MAXIMUM 60 PEOPLE.

FURTHER DETAIL FROM DORIS SCUTCHINGS ON

AYLESBURY (01296) 681 243

Cost;- £5.00 per hour + metered electricity
£2.00 per hour + metered electricity for residents of the parish

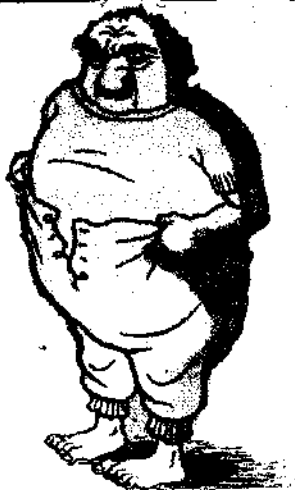

**Dave
Lewis
(Managing
Director)**

**'Star' of 'The Bull Monty'!!
Free autograph with every T.V. or video
repair.**

FLACKWELL ELECTRONICS

**Church Farm, Aston Abbots
TV. VIDEO & SATELLITE
SERVICING**

**General Repairs
(MOST MAKES REPAIRED THE
SAME DAY)**

Rentals, New and Used Sales

No call out fee within Aston Abbott
Phone David Lewis on 682126 for details.

BACK PAGE.

Alison J Whittaker, B.A. Hons. Music

*Piano, Electric Keyboard &
Theory of Music Teacher*

10 Recreation Ground Cottages
Wingrave,
Nr. Aylesbury
Bucks. HP22 4PH Tel; (01296) 681639

BIGNELL & BRANDON

*Carpentry, Glazing,
General Building and Maintenance*

Aylesbury 681242 Aylesbury 432390
Mobile 0468 115527 Mobile 0468 126612

**ASTON ABBOTTS
CHURCH ROOM**

AVAILABLE FOR WEDDING RECEPTIONS: BIRTHDAY
PARTIES: FOLK EVENINGS: DANCES: BINGO ETC...

MAXIMUM 60 PEOPLE.

FURTHER DETAIL FROM DORIS SCUTCHINGS ON

AYLESBURY (01296) 681 243

Cost;- £5.00 per hour + metered electricity
£2.00 per hour + metered electricity for residents of the parish



**Dave
Lewis**
(Managing
Director)

Star' of 'The Bull Monty'!!
*Free autograph with every T.V. or video
repair.*

**FLACKWELL
ELECTRONICS**

**Church Farm, Aston Abbots
TV. VIDEO & SATELLITE
SERVICING**

**General Repairs
(MOST MAKES REPAIRED THE
SAME DAY)**

Rentals, New and Used Sales

No call out fee within Aston Abbott
Phone David Lewis on 682126 for details.

Alison J Whittaker, B.A. Hons. Music

*Piano, Electric Keyboard &
Theory of Music Teacher*

10 Recreation Ground Cottages

Wingrave,

Nr. Aylesbury

Bucks. HP22 4PH

Tel; (01296) 681639

BIGNELL & BRANDON

*Carpentry, Glazing,
General Building and Maintenance*

Aylesbury 681242 Aylesbury 432390

Mobile 0468 115527 Mobile 0468 126612

ASTON ABBOTTS

CHURCH ROOM

AVAILABLE FOR WEDDING RECEPTIONS: BIRTHDAY
PARTIES: FOLK EVENINGS: DANCES: BINGO ETC...

MAXIMUM 60 PEOPLE.

FURTHER DETAIL FROM DORIS SCUTCHINGS ON

AYLESBURY (01296) 681 243

Cost;- £5.00 per hour + metered electricity
£2.00 per hour + metered electricity for residents of the parish

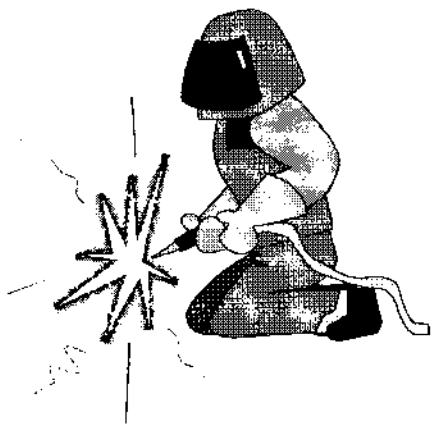

*Oh well!! The lottery money has all gone
and the fame of being a Star' of 'The Bull
Monty' has worn off so it's back to
repairing tellies
Dave Lewis*

**FLACKWELL
ELECTRONICS**

Church Farm, Aston Abbots
**TV. VIDEO & SATELLITE
SERVICING**

**General Repairs
(MOST MAKES REPAIRED THE
SAME DAY)**

Rentals, New and Used Sales

No call out fee within Aston Abbott
Phone David Lewis on 682126 for details.

Back Page

Chron1

Alison J Whittaker, B.A. Hons. Music

*Piano, Electric Keyboard &
Theory of Music Teacher*

10 Recreation Ground Cottages
Wingrave,
Nr. Aylesbury
Bucks. HP22 4PH Tel; (01296) 681639

BIGNELL & BRANDON

*Carpentry, Glazing,
General Building and Maintenance*

Aylesbury 681242 Aylesbury 432390
Mobile 0468 115527 Mobile 0468 126612

ASTON ABBOTTS

CHURCH ROOM

AVAILABLE FOR WEDDING RECEPTIONS: BIRTHDAY
PARTIES: FOLK EVENINGS: DANCES: BINGO ETC...

MAXIMUM 60 PEOPLE.

FURTHER DETAIL FROM DORIS SCUTCHINGS ON

AYLESBURY (01296) 681 243

Cost;- £5.00 per hour + metered electricity
£2.00 per hour + metered electricity for residents of the parish



*You must be joking!!
Me repair tellies?*

*After season in 'The Monty',
an offer to do a repeat performance
in Germany
and,*

*a recent appearance in
the prestigious Cabaret;*

It's an actors life for me!

**FLACKWELL
ELECTRONICS**

**Church Farm, Aston Abbots
TV. VIDEO & SATELLITE
SERVICING**

**General Repairs
(MOST MAKES REPAIRED THE
SAME DAY)**

Rentals, New and Used Sales

No call out fee within Aston Abbott
Phone David Lewis on 682126 for details.

Back Page

Chroni

Alison J Whittaker, B.A. Hons. Music

*Piano, Electric Keyboard &
Theory of Music Teacher*

10 Recreation Ground Cottages
Wingrave,
Nr. Aylesbury
Bucks. HP22 4PH Tel; (01296) 681639

BIGNELL & BRANDON

*Carpentry, Glazing,
General Building and Maintenance*

Aylesbury 681242 Aylesbury 432390

Mobile 0468 115527 Mobile 0468 126612

ASTON ABBOTTS

CHURCH ROOM

AVAILABLE FOR WEDDING RECEPTIONS: BIRTHDAY
PARTIES: FOLK EVENINGS: DANCES: BINGO ETC...

MAXIMUM 60 PEOPLE.

FURTHER DETAIL FROM DORIS SCUTCHINGS ON

AYLESBURY (01296) 681 243

Cost;- £5.00 per hour + metered electricity
£2.00 per hour + metered electricity for residents of the parish



*You must be joking!!
Me repair tellies?*

*After season in 'The Monty',
an offer to do a repeat performance
in Germany*

*and,
a recent appearance in
the prestigious Cabaret;*

It's an actors life for me!

**FLACKWELL
ELECTRONICS**

**Church Farm, Aston Abbots
TV. VIDEO & SATELLITE
SERVICING**

**General Repairs
(MOST MAKES REPAIRED THE
SAME DAY)**

Rentals, New and Used Sales

No call out fee within Aston Abbott
Phone David Lewis on 682126 for details.

Back Page

Chron1

Alison J Whittaker, B.A. Hons. Music

*Piano, Electric Keyboard &
Theory of Music Teacher*

10 Recreation Ground Cottages
Wingrave,
Nr. Aylesbury
Bucks. HP22 4PH

Tel: (01296) 681639

BIGNELL & BRANDON

*Carpentry, Glazing,
General Building and Maintenance*

Aylesbury 681242 Aylesbury 432390

Mobile 0468 115527 Mobile 0468 126612

ASTON ABBOTTS

CHURCH ROOM

**AVAILABLE FOR WEDDING RECEPTIONS: BIRTHDAY
PARTIES: FOLK EVENINGS: DANCES: BINGO ETC...**

MAXIMUM 60 PEOPLE.

FURTHER DETAIL FROM DORIS SCUTCHINGS ON

AYLESBURY (01296) 681 243

**Cost:- £5.00 per hour + metered electricity
£2.00 per hour + metered electricity for residents of the parish**

Many bewildered parents have had to explain to their enquiring offspring the reason for the name on the number plate fixed to the garage of a certain No. 20 The Green. The very same same plate that features on treasure hunt questionnaires often pondered over by lonely souls as they wander the village.

Now however, the sign is in great demand by Allison of the haunting yet 'lyrical laugh'. She has demanded I buy it for her and fix it to one of our barns where it will serve a most useful service (she says). - What ever does she mean??

Why not ask her when next you meet?

FLACKWELL ELECTRONICS

**Church Farm, Aston Abbots
TV. VIDEO & SATELLITE
SERVICING**

**General Repairs
(MOST MAKES REPAIRED THE
SAME DAY)**

Rentals, New and Used Sales

**No call out fee within Aston Abbott
Phone David Lewis on 682126 for details.**

Back page

C/Ads

Alison J Whittaker, B.A. Hons. Music

*Piano, Electric Keyboard &
Theory of Music Teacher*

10 Recreation Ground Cottages
Wingrave,
Nr. Aylesbury
Bucks. HP22 4PH

Tel; (01296) 681639

BIGNELL & BRANDON

*Carpentry, Glazing,
General Building and Maintenance*

Aylesbury 681242 Aylesbury 432390

Mobile 0468 115527 Mobile 0468 126612

ASTON ABBOTTS

CHURCH ROOM

AVAILABLE FOR WEDDING RECEPTIONS: BIRTHDAY
PARTIES: FOLK EVENINGS: DANCES: BINGO ETC...

MAXIMUM 60 PEOPLE.

FURTHER DETAIL FROM DORIS SCUTCHINGS ON

AYLESBURY (01296) 681 243

Cost;- £5.00 per hour + metered electricity
£2.00 per hour + metered electricity for residents of the parish

**HELP!
PLEASE GIVE
GENEROUSLY**

*Wife with uncontrollable craving for
strawberries. all donations whether
cash, strawberries (any condition),
medical advice, strawberry jam or even
strawberry plants will be gratefully
received.*

Dave Lewis.



**FLACKWELL
ELECTRONICS**

**Church Farm, Aston Abbots
TV. VIDEO & SATELLITE
SERVICING**

**General Repairs
(MOST MAKES REPAIRED THE
SAME DAY)**

Rentals, New and Used Sales

No call out fee within Aston Abbott
Phone David Lewis on 682126 for details.

Back Page

C/Ads

Alison J Whittaker, B.A. Hons. Music

**Piano, Electric Keyboard &
Theory of Music Teacher**

10 Recreation Ground Cottages
Wingrave,
Nr. Aylesbury
Bucks. HP22 4PH Tel; (01296) 681639

BIGNELL & BRANDON

**Carpentry, Glazing,
General Building and Maintenance**

Aylesbury 681242 Aylesbury 432390

Mobile 0468 115527 Mobile 0468 126612

**ASTON ABBOTTS
CHURCH ROOM**

**AVAILABLE FOR WEDDING RECEPTIONS: BIRTHDAY
PARTIES: FOLK EVENINGS: DANCES: BINGO ETC...**

MAXIMUM 60 PEOPLE.

FURTHER DETAIL FROM DORIS SCUTCHINGS ON

AYLESBURY (01296) 681 243

**Cost:- £5.00 per hour + metered electricity
£2.00 per hour + metered electricity for residents of the parish**

THE Aston Abbotts Music Maestro



DLT

Come on, pop pickers, ask me a music trivia question. I'll answer anything on the 60's, the 70's, and er.. the 80's (1981 might be OK as well).

Go on - ask me! I know who recorded "itsy bitsy teeny weeny yellow polka dot bikini" - so ask me another look out for my travelling music podium in the Village

**Dave Lewis Travesty (DLT)
the Aston Abbotts Music Maestro**

**FLACKWELL
ELECTRONICS**

Church Farm, Aston Abbotts

TV. VIDEO & SATELLITE

SERVICING

General Repairs

**(MOST MAKES REPAIRED THE
SAME DAY)**

Rentals, New and Used Sales

**No call out fee within Aston Abbotts
Phone David Lewis on 682126 for details.**

FLACKWELL ELECTRONICS

OF CHURCH FARM, ASTON ABBOTTS

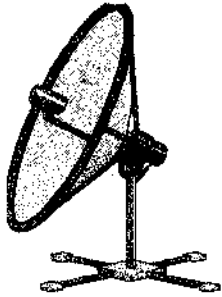

**T.V. VIDEO AND
SATELLITE
SERVICING AND
GENERAL REPAIR**

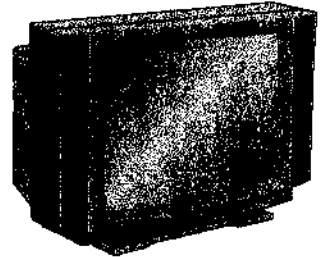

**MOST MAKES
REPAIRED
THE SAME
DAY**

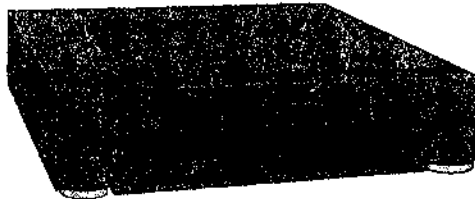

**NO CALL OUT
FEE WITHIN
ASTON
ABBOTTS**

**PHONE DAVE LEWIS
ON 01296 682126**

Ah! Perfect for transporting records to my Music Podium ! Nobby, ask me one from your 80's box !

Dave Lewis finds inspiration at the Brookside Bar-B-Q

**FRIENDLY
SERVICE**

DLT

**The Aston Abbots
Music Maestro**

BACK PAGE THE CHRONICLE

FLACKWELL ELECTRONICS

OF CHURCH FARM, ASTON ABBOTTS

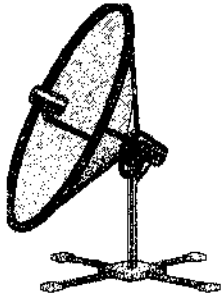

**T.V. VIDEO AND
SATELLITE
SERVICING AND
GENERAL REPAIR**

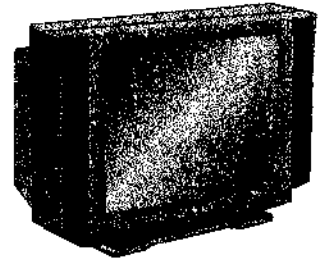

**RENTALS, NEW
AND USED SALES**

**MOST MAKES
REPAIRED
THE SAME
DAY**

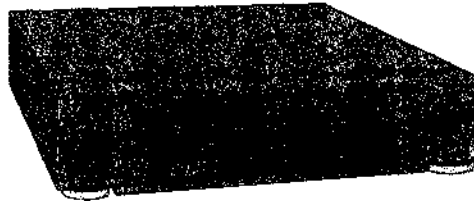

**NO CALL OUT
FEE WITHIN
ASTON
ABBOTTS**

**PHONE DAVE LEWIS
ON 01296 682126**

"I don't know - the crickets on Channel 4, England's footballers chasing shadows at Wembley, three degrees outside last night - how many *more* 60's bands are going to reform?"

**FRIENDLY
SERVICE**

DLT



**The Aston Abbots
Music Maestro**

BACK PAGE THE CHRONICLE

FLACKWELL ELECTRONICS

OF CHURCH FARM, ASTON ABBOTTS

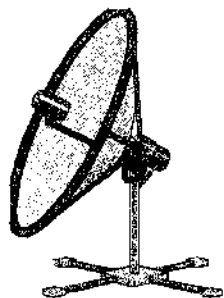

**T.V. VIDEO AND
SATELLITE
SERVICING AND
GENERAL REPAIR**

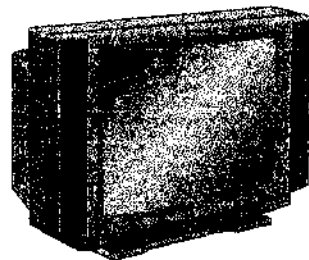

**RENTALS, NEW
AND USED SALES**

**MOST MAKES
REPAIRED
THE SAME
DAY**

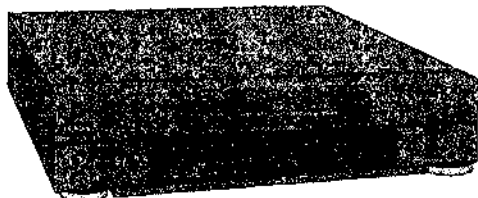

**NO CALL OUT
FEE WITHIN
ASTON
ABBOTTS**

**PHONE DAVE LEWIS
ON 01296 682126**

I'm leaving on a jet plane
I won't take no cash back home again...

Don't spend
all of our cash!

**FRIENDLY
SERVICE**

DLT

**The Aston Abbots
Music Maestro**

BACK PAGE THE CHRONICLE

FLACKWELL ELECTRONICS

OF CHURCH FARM, ASTON ABBOTTS

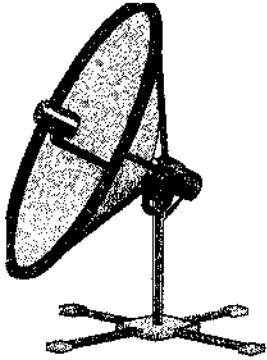

**T.V. VIDEO AND
SATELLITE
SERVICING AND
GENERAL REPAIR**

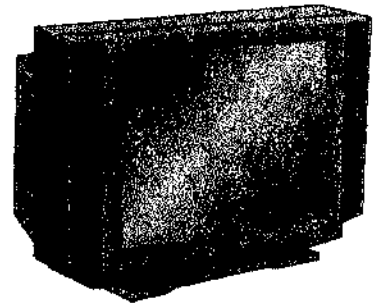

**RENTALS, NEW
AND USED SALES**

**MOST MAKES
REPAIRED
THE SAME
DAY**

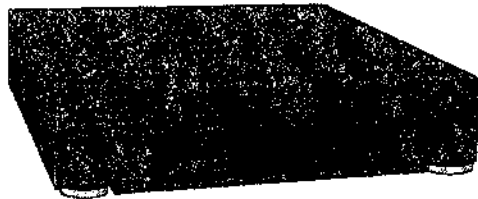

**NO CALL OUT
FEE WITHIN
ASTON
ABBOTTS**

**PHONE DAVE LEWIS
ON 01296 682126**

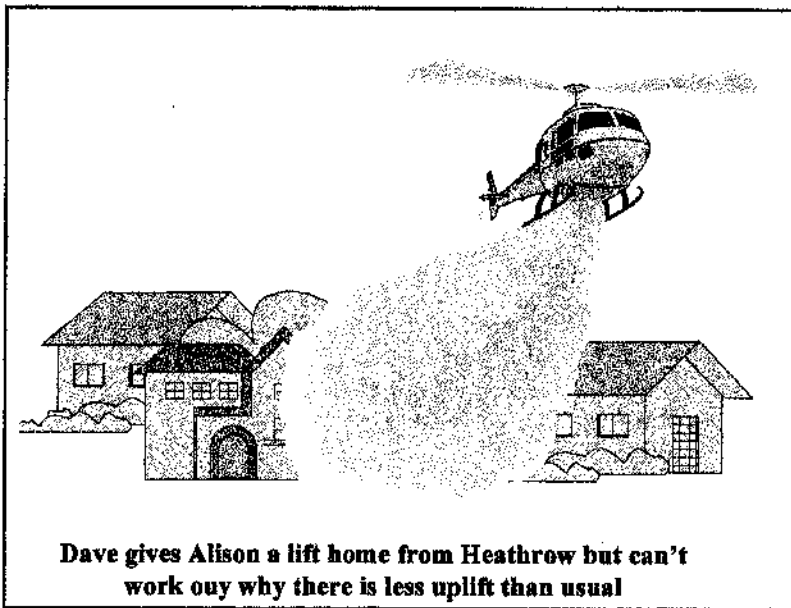

Dave gives Alison a lift home from Heathrow but can't work out why there is less uplift than usual

**FRIENDLY
SERVICE**



BACK PAGE THE CHRONICLE

FLACKWELL ELECTRONICS

OF CHURCH FARM, ASTON ABBOTTS

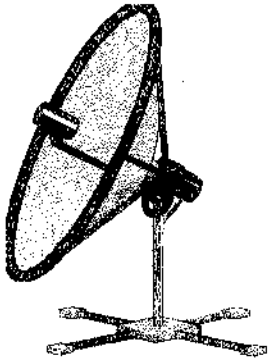

**T.V. VIDEO AND
SATELLITE
SERVICING AND
GENERAL REPAIR**

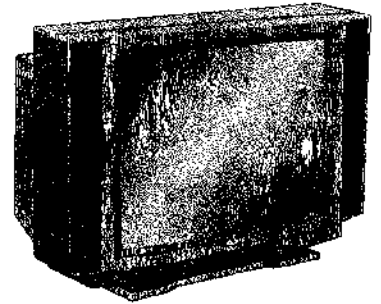

**RENTALS, NEW
AND USED SALES**

**MOST MAKES
REPAIRED
THE SAME
DAY**



**NO CALL OUT
FEE WITHIN
ASTON
ABBOTTS**

**PHONE DAVE LEWIS
ON 01296 682126**

Let's see registered
Chiropracist ...registered
Chiropractorregistered
Childminder... ah, here it is
... Registered Charity!!

Flackwell Electronics

**FRIENDLY
SERVICE**

DLT

**The Aston Abbotts
Music Maestro**

BACK PAGE THE CHRONICLE

FLACKWELL ELECTRONICS

OF CHURCH FARM, ASTON ABBOTTS

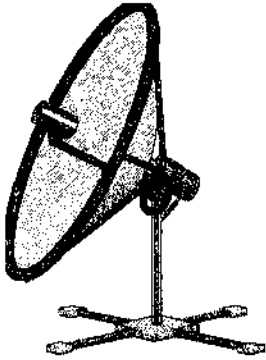

**T.V. VIDEO AND
SATELLITE
SERVICING AND
GENERAL REPAIR**

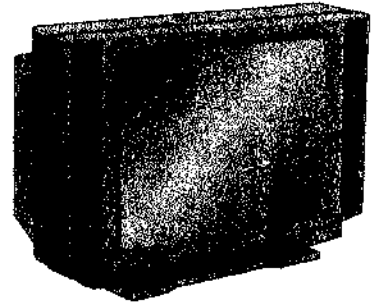

**RENTALS, NEW
AND USED SALES**

**MOST MAKES
REPAIRED
THE SAME
DAY**

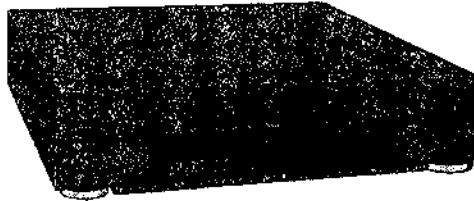

**NO CALL OUT
FEE WITHIN
ASTON
ABBOTTS**

**PHONE DAVE LEWIS
ON 01296 682126**

DLT
From Tellies
to Hellies

£75,000

£95,000

£70,000

**For sale - nearly
new helicopters..**

**WOT A LOTTA
CHOPPERS WE
GOTTA ...**

Dave has never been slow to spot an opportunity

**FRIENDLY
SERVICE**

DLT

**The Aston Abbotts
Music Maestro**

BACK PAGE THE CHRONICLE

FLACKWELL ELECTRONICS

OF CHURCH FARM, ASTON ABBOTTS

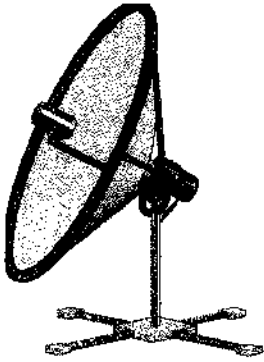

**T.V. VIDEO AND
SATELLITE
SERVICING AND
GENERAL REPAIR**

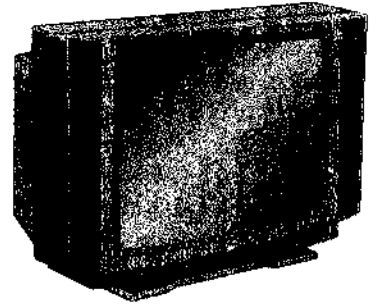

**RENTALS, NEW
AND USED SALES**

**MOST MAKES
REPAIRED
THE SAME
DAY**



**NO CALL OUT
FEE WITHIN
ASTON
ABBOTTS**

**PHONE DAVE LEWIS
ON 01296 682126**

**FRIENDLY
SERVICE**



**So what birthday present do you buy
for the girl with everything?**

DLT



**The Aston Abbotts
Music Maestro**

BACK PAGE THE CHRONICLE

FLACKWELL ELECTRONICS

OF CHURCH FARM, ASTON ABBOTTS

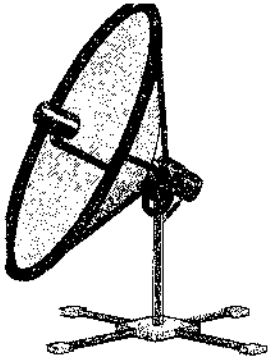

**T.V. VIDEO AND
SATELLITE
SERVICING AND
GENERAL REPAIR**

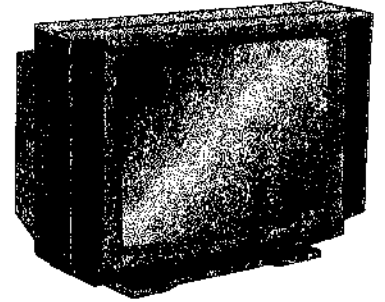

**RENTALS, NEW
AND USED SALES**



**MOST MAKES
REPAIRED
THE SAME
DAY**

**NO CALL OUT
FEE WITHIN
ASTON
ABBOTTS**

**PHONE DAVE LEWIS
ON 01296 682126**

Aston Abbots 1mile

Yes, Air Commodore - there's plenty of room for Apaches at the heliport.

David could be about to make a big mistake....

**FRIENDLY
SERVICE**

DLT

The Aston Abbots
Music Maestro

BACK PAGE THE CHRONICLE

FLACKWELL ELECTRONICS

OF CHURCH FARM, ASTON ABBOTTS

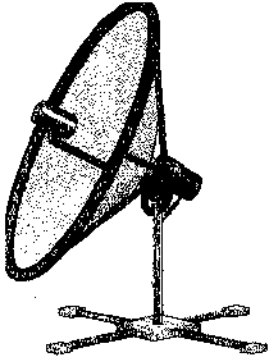

**T.V. VIDEO AND
SATELLITE
SERVICING AND
GENERAL REPAIR**

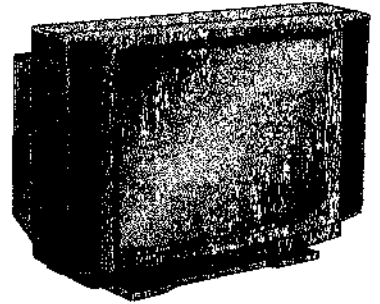

**RENTALS, NEW
AND USED SALES**

**MOST MAKES
REPAIRED
THE SAME
DAY**

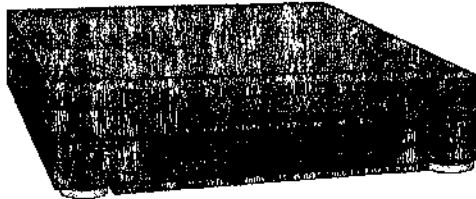

**NO CALL OUT
FEE WITHIN
ASTON
ABBOTTS**

**PHONE DAVE LEWIS
ON 01296 682126**

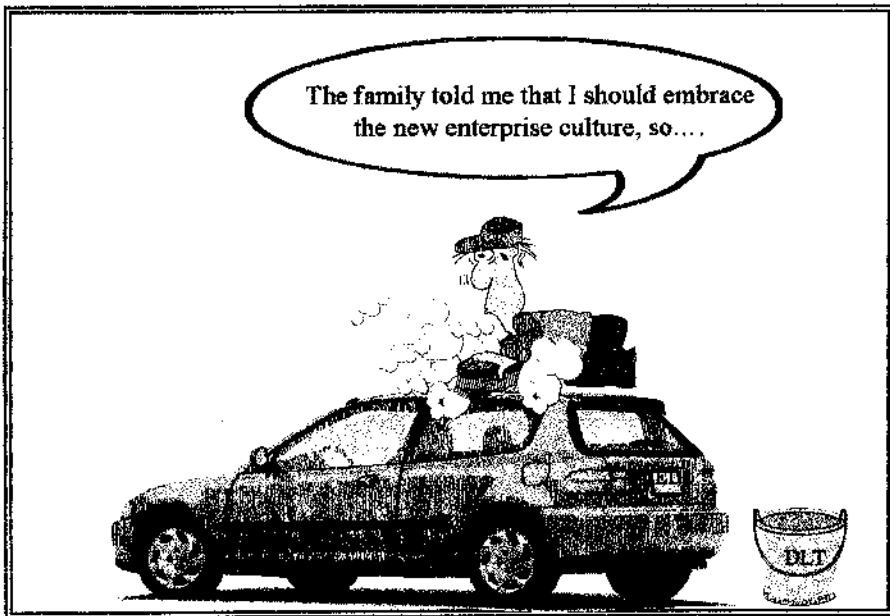

**FRIENDLY
SERVICE**



BACK PAGE THE CHRONICLE

FLACKWELL ELECTRONICS

OF CHURCH FARM, ASTON ABBOTTS

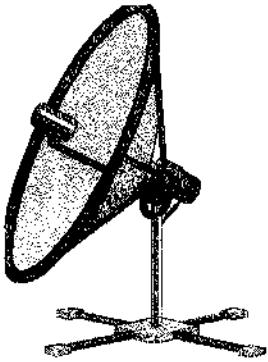

**T.V. VIDEO AND
SATELLITE
SERVICING AND
GENERAL REPAIR**

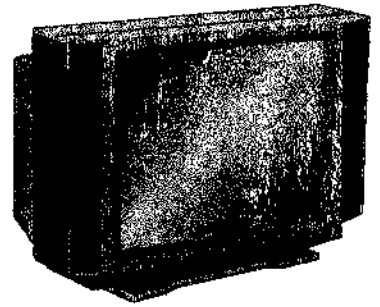

**RENTALS, NEW
AND USED SALES**

**MOST MAKES
REPAIRED
THE SAME
DAY**



**NO CALL OUT
FEE WITHIN
ASTON
ABBOTTS**

**PHONE DAVE LEWIS
ON 01296 682126**



**NORMAL
SERVICE WILL
BE RESUMED AS
SOON AS
POSSIBLE**

Not much inspiration from the Lewis household for the jokethis month! Ed.

**FRIENDLY
SERVICE**



BACK PAGE THE CHRONICLE

FLACKWELL ELECTRONICS

OF CHURCH FARM, ASTON ABBOTTS

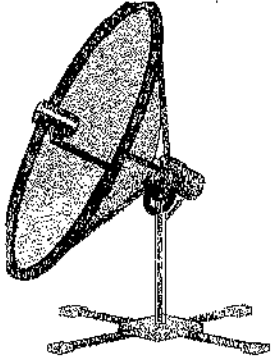

**T.V. VIDEO AND
SATELLITE
SERVICING AND
GENERAL REPAIR**

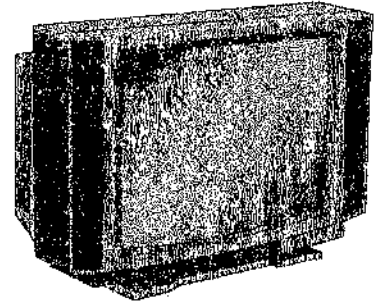

**RENTALS, NEW
AND USED SALES**

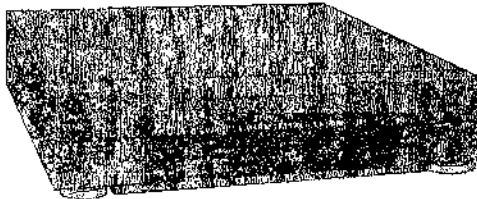

**MOST MAKES
REPAIRED
THE SAME
DAY**

**NO CALL OUT
FEE WITHIN
ASTON
ABBOTTS**

**PHONE DAVE LEWIS
ON 01296 682126**

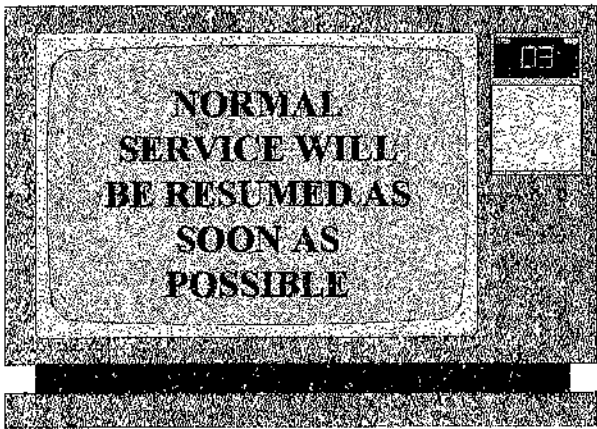

**NORMAL
SERVICE WILL
BE RESUMED AS
SOON AS
POSSIBLE**

Does anybody have any good Dave Lewis stories from the holidays? I will pay generously for all good contributions, especially if they are untrue!
Ed.

**FRIENDLY
SERVICE**



BACK PAGE THE CHRONICLE

FLACKWELL ELECTRONICS

OF CHURCH FARM, ASTON ABBOTTS

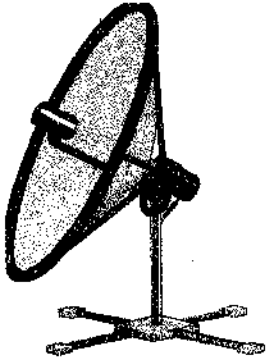

**T.V. VIDEO AND
SATELLITE
SERVICING AND
GENERAL REPAIR**

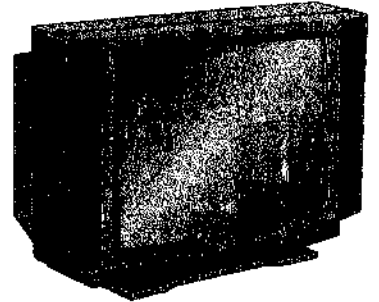

**RENTALS, NEW
AND USED SALES**

**MOST MAKES
REPAIRED
THE SAME
DAY**

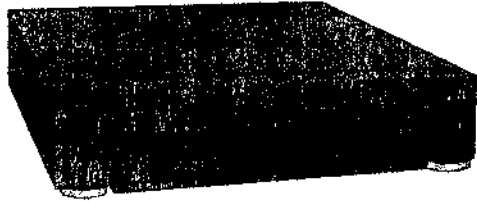

**NO CALL OUT
FEE WITHIN
ASTON
ABBOTTS**

**PHONE DAVE LEWIS
ON 01296 682126**



Dave ponders the task set by Whytie-

But what was it?
Did he succeed?
And what fiendish
revenge did he exact?

Answers next month,
perhaps.....

**FRIENDLY
SERVICE**

DLT



**The Aston Abbotts
Music Maestro**

BACK PAGE THE CHRONICLE

FLACKWELL ELECTRONICS

OF CHURCH FARM, ASTON ABBOTTS

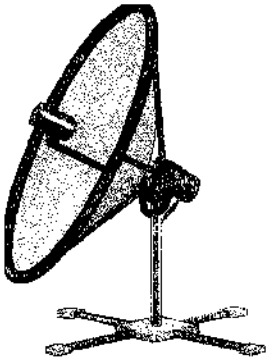

**T.V. VIDEO AND
SATELLITE
SERVICING AND
GENERAL REPAIR**

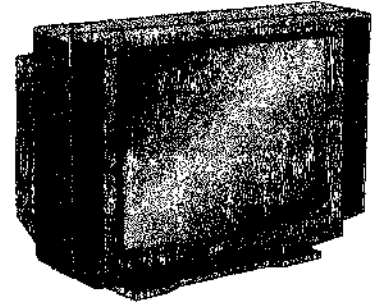

**RENTALS, NEW
AND USED SALES**

**MOST MAKES
REPAIRED
THE SAME
DAY**

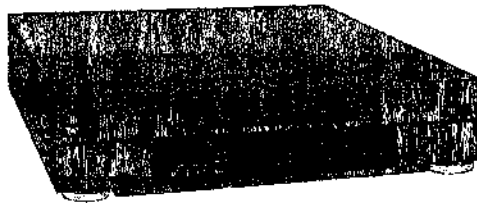

**NO CALL OUT
FEE WITHIN
ASTON
ABBOTTS**

**PHONE DAVE LEWIS
ON 01296 682126**

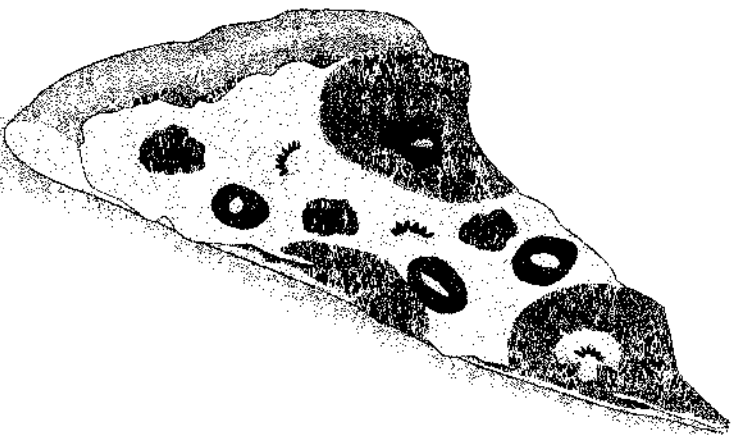

Site sponsored by The Deep Pan Pizza Company.....

**FRIENDLY
SERVICE**



BACK PAGE THE CHRONICLE

FLACKWELL ELECTRONICS

OF CHURCH FARM, ASTON ABBOTTS

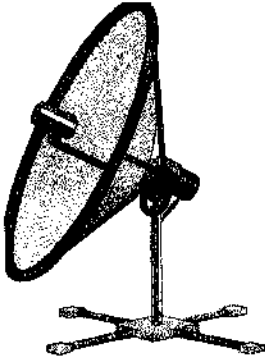

**T.V. VIDEO AND
SATELLITE
SERVICING AND
GENERAL REPAIR**

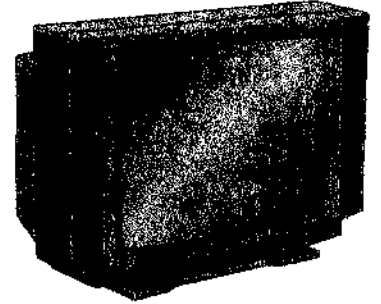

**RENTALS, NEW
AND USED SALES**

**MOST MAKES
REPAIRED
THE SAME
DAY**

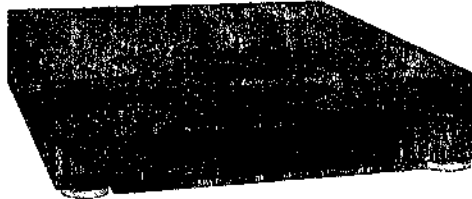

**NO CALL OUT
FEE WITHIN
ASTON
ABBOTTS**

**PHONE DAVE LEWIS
ON 01296 682126**

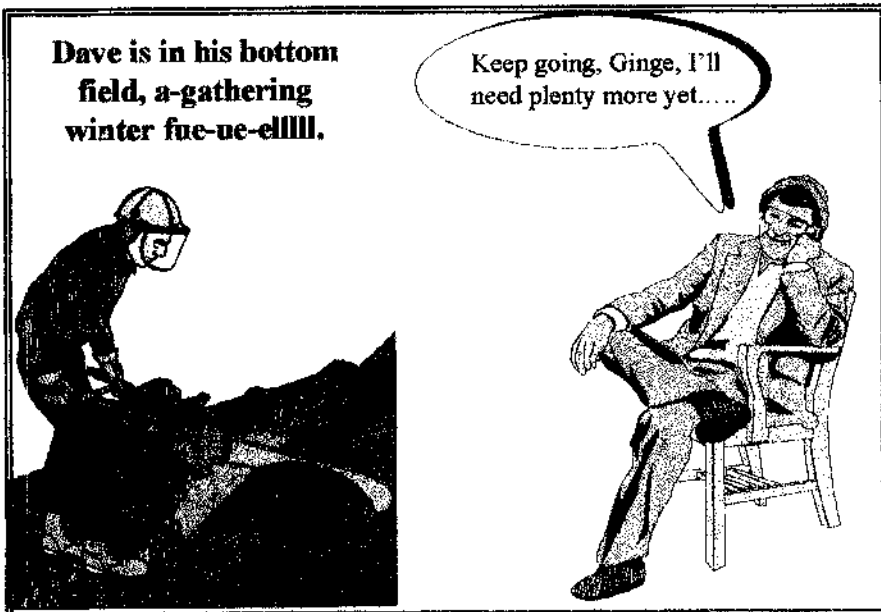

**FRIENDLY
SERVICE**



BACK PAGE THE CHRONICLE

FLACKWELL ELECTRONICS

OF CHURCH FARM, ASTON ABBOTTS

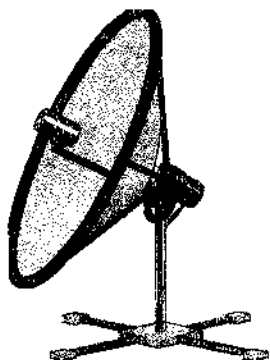

**T.V. VIDEO AND
SATELLITE
SERVICING AND
GENERAL REPAIR**

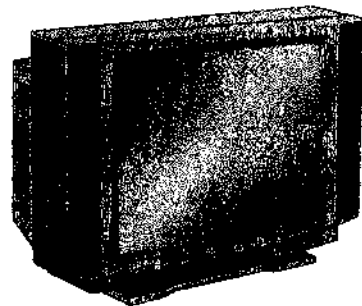

**RENTALS, NEW
AND USED SALES**

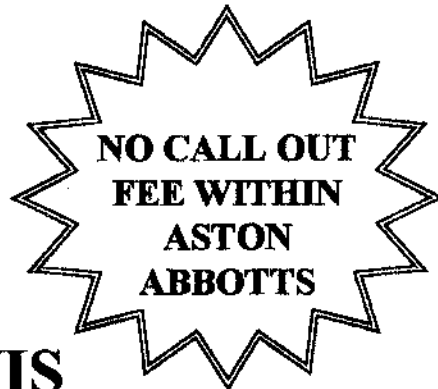

**PHONE DAVE LEWIS
ON 01296 682126**



Dave saved the day when he got his 55" whopper out at the Aston Abbots Millennium Party - now everybody would see 'Big Ben' at Midnight.

ALWAYS THE BIGGEST TVs AT FLACKWELL...

**FRIENDLY
SERVICE**



BACK PAGE THE CHRONICLE

FLACKWELL ELECTRONICS

OF CHURCH FARM, ASTON ABBOTTS

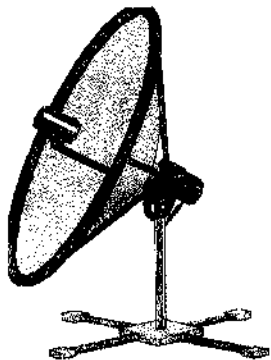

**T.V. VIDEO AND
SATELLITE
SERVICING AND
GENERAL REPAIR**

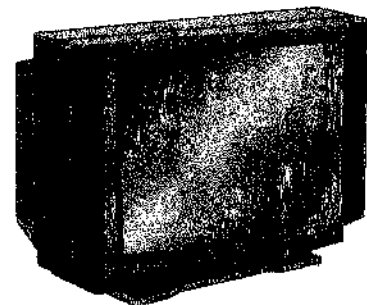

**RENTALS, NEW
AND USED SALES**

**MOST MAKES
REPAIRED
THE SAME
DAY**



**NO CALL OUT
FEE WITHIN
ASTON
ABBOTTS**

**PHONE DAVE LEWIS
ON 01296 682126**

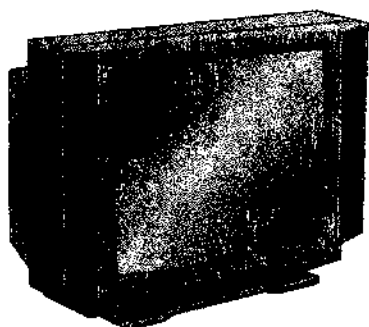

The famous 55" TV

Dave's whopper is gaining celebrity status as it makes yet another guest appearance - this time at The AAH Exhibition. At this rate it won't be long before somebody tries to buy it...

**FRIENDLY
SERVICE**

DLT



**The Aston Abbots
Music Maestro**

BACK PAGE THE CHRONICLE

FLACKWELL ELECTRONICS

OF CHURCH FARM, ASTON ABBOTTS

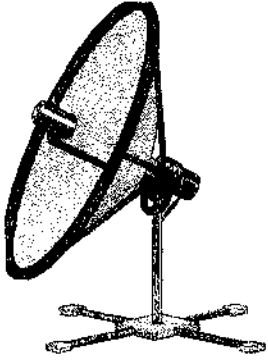

**T.V. VIDEO AND
SATELLITE
SERVICING AND
GENERAL REPAIR**

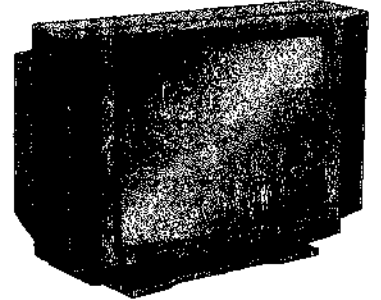

**RENTALS, NEW
AND USED SALES**

**MOST MAKES
REPAIRED
THE SAME
DAY**



**NO CALL OUT
FEE WITHIN
ASTON
ABBOTTS**

**PHONE DAVE LEWIS
ON 01296 682126**

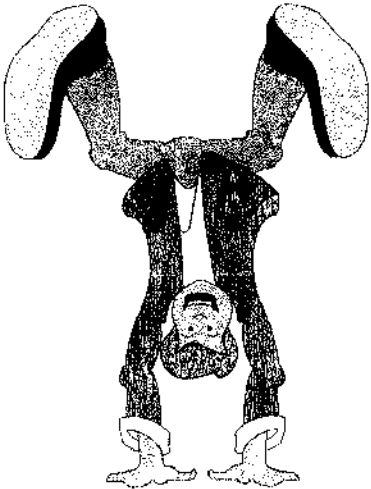

Dave hears the news about the 60s & 70s Disco and immediately starts rehearsing his Saturday Night Fever routine.

**FRIENDLY
SERVICE**



BACK PAGE THE CHRONICLE

FLACKWELL ELECTRONICS

OF CHURCH FARM, ASTON ABBOTTS

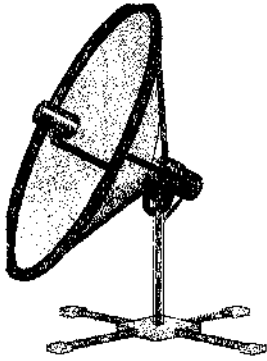

**T.V. VIDEO AND
SATELLITE
SERVICING AND
GENERAL REPAIR**

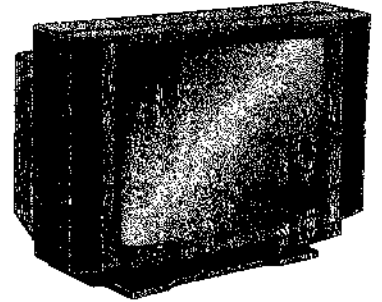

**RENTALS, NEW
AND USED SALES**

**MOST MAKES
REPAIRED
THE SAME
DAY**



**NO CALL OUT
FEE WITHIN
ASTON
ABBOTTS**

**PHONE DAVE LEWIS
ON 01296 682126**

Oi Lewis - you told me this would be cheaper than Bernards. I want my money back!

Wilks

Bienvenue a L'Isle de Chiens

The EU thwarts Dave's latest entrepreneurial idea (full story page 8)

**FRIENDLY
SERVICE**

DLT

**The Aston Abbots
Music Maestro**

BACK PAGE THE CHRONICLE

FLACKWELL ELECTRONICS

OF CHURCH FARM, ASTON ABBOTTS

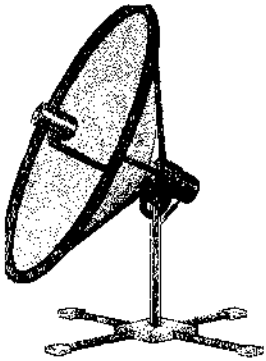

**T.V. VIDEO AND
SATELLITE
SERVICING AND
GENERAL REPAIR**

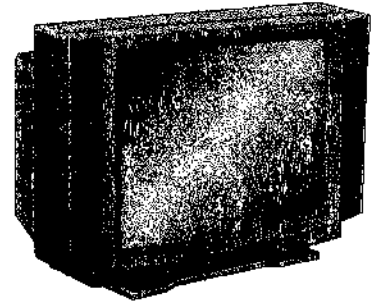

**RENTALS, NEW
AND USED SALES**



**MOST MAKES
REPAIRED
THE SAME
DAY**

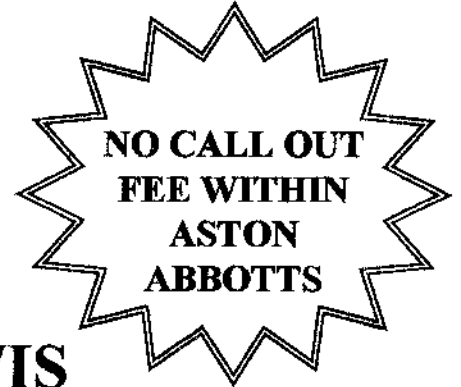
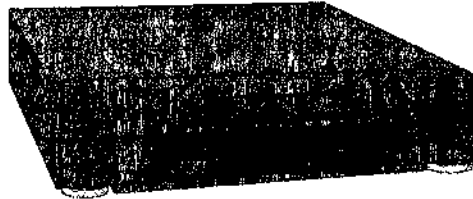

**NO CALL OUT
FEE WITHIN
ASTON
ABBOTTS**

**PHONE DAVE LEWIS
ON 01296 682126**

Unable to use the Aston Abbotts Helipad, Dave sets off on foot to begin his one man protest at Luton Airport - read his story in next month's issue...

**FRIENDLY
SERVICE**

DLT

**The Aston Abbotts
Music Maestro**

BACK PAGE THE CHRONICLE

FLACKWELL ELECTRONICS

OF CHURCH FARM, ASTON ABBOTTS

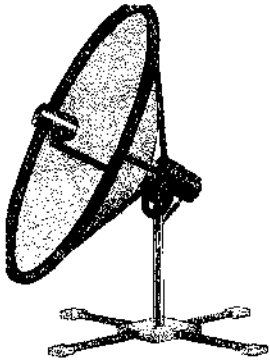

**T.V. VIDEO AND
SATELLITE
SERVICING AND
GENERAL REPAIR**

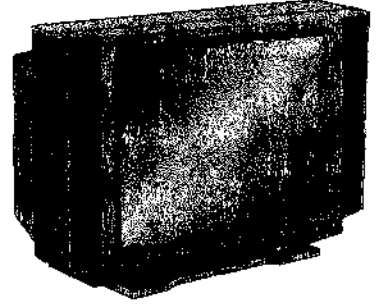

**RENTALS, NEW
AND USED SALES**

**MOST MAKES
REPAIRED
THE SAME
DAY**



**NO CALL OUT
FEE WITHIN
ASTON
ABBOTTS**

**PHONE DAVE LEWIS
ON 01296 682126**

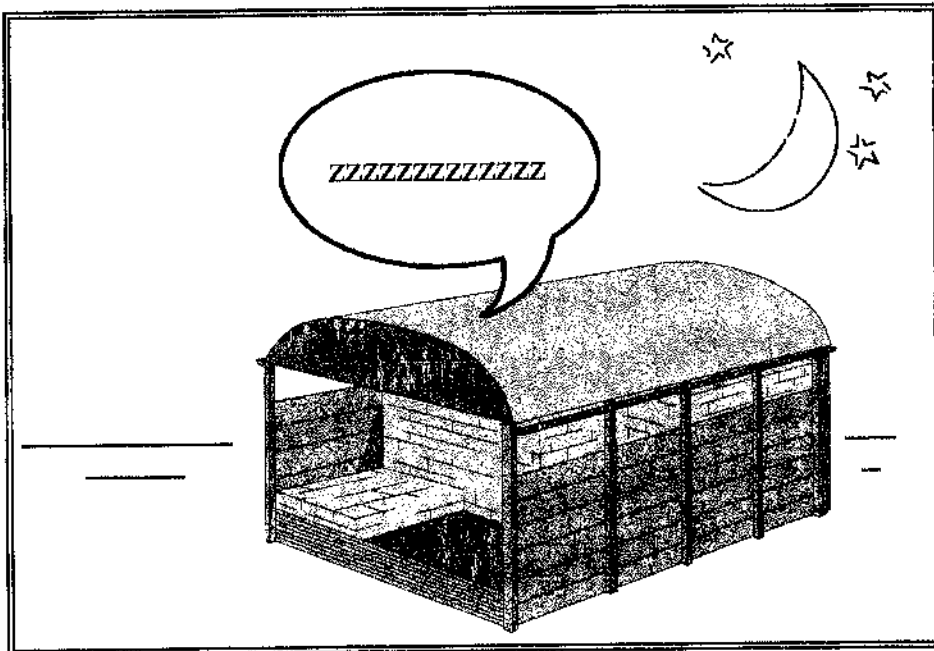

**FRIENDLY
SERVICE**



BACK PAGE THE CHRONICLE

FLACKWELL ELECTRONICS

OF CHURCH FARM, ASTON ABBOTTS

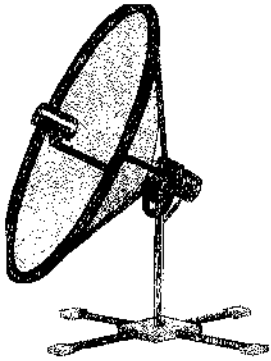

**T.V. VIDEO AND
SATELLITE
SERVICING AND
GENERAL REPAIR**

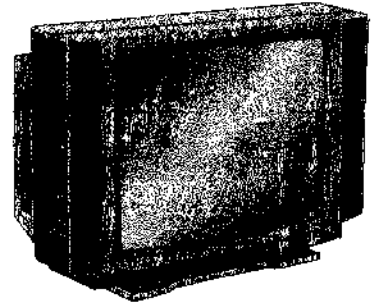

**RENTALS, NEW
AND USED SALES**

**MOST MAKES
REPAIRED
THE SAME
DAY**

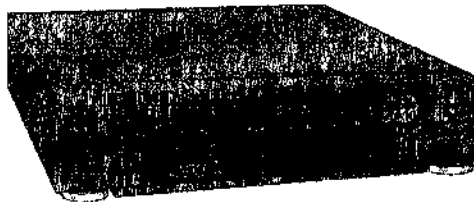

**NO CALL OUT
FEE WITHIN
ASTON
ABBOTTS**

**PHONE DAVE LEWIS
ON 01296 682126**

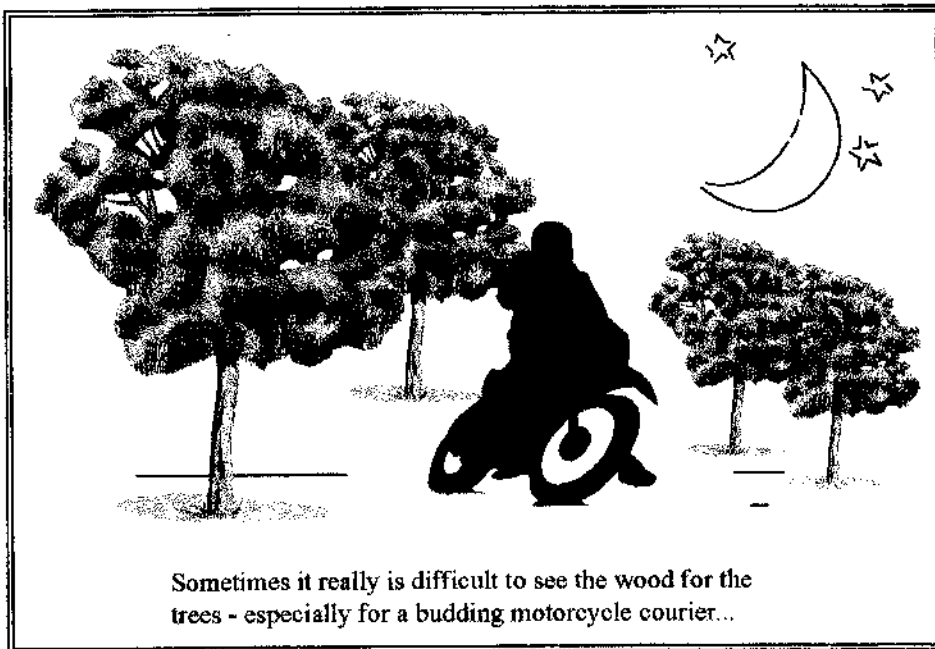

Sometimes it really is difficult to see the wood for the trees - especially for a budding motorcycle courier...

**FRIENDLY
SERVICE**



BACK PAGE THE CHRONICLE

FLACKWELL ELECTRONICS

OF CHURCH FARM, ASTON ABBOTTS

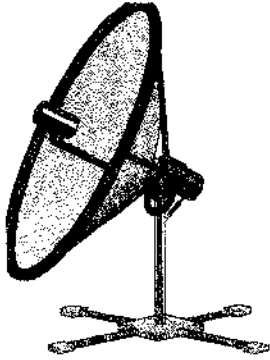

**T.V. VIDEO AND
SATELLITE
SERVICING AND
GENERAL REPAIR**

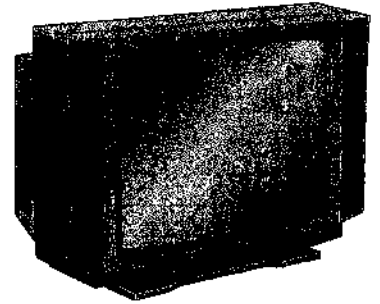

**RENTALS, NEW
AND USED SALES**

**MOST MAKES
REPAIRED
THE SAME
DAY**

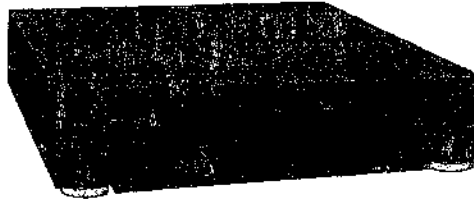

**NO CALL OUT
FEE WITHIN
ASTON
ABBOTTS**

**PHONE DAVE LEWIS
ON 01296 682126**

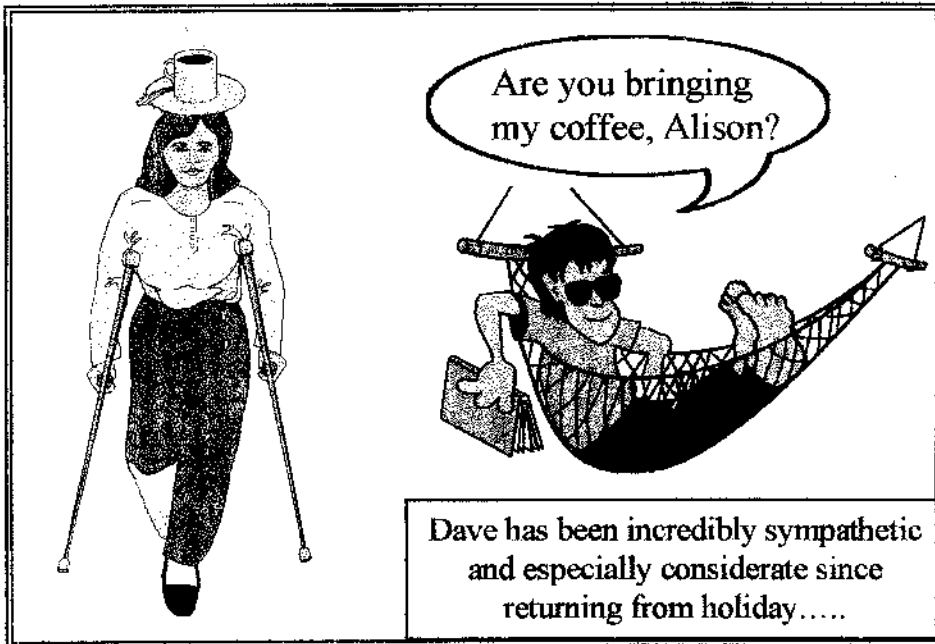

Are you bringing my coffee, Alison?

Dave has been incredibly sympathetic and especially considerate since returning from holiday.....

**FRIENDLY
SERVICE**



BACK PAGE THE CHRONICLE

FLACKWELL ELECTRONICS

OF CHURCH FARM, ASTON ABBOTTS

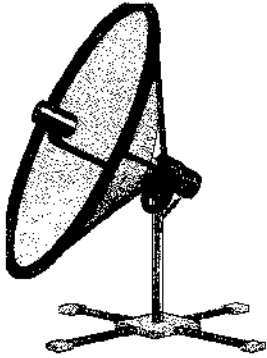

**T.V. VIDEO AND
SATELLITE
SERVICING AND
GENERAL REPAIR**

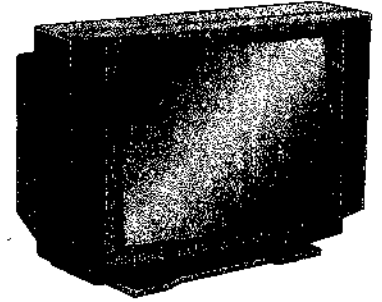

**RENTALS, NEW
AND USED SALES**



**MOST MAKES
REPAIRED
THE SAME
DAY**

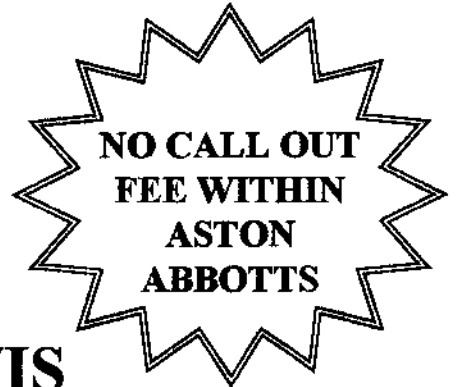

**NO CALL OUT
FEE WITHIN
ASTON
ABBOTTS**

**PHONE DAVE LEWIS
ON 01296 682126**

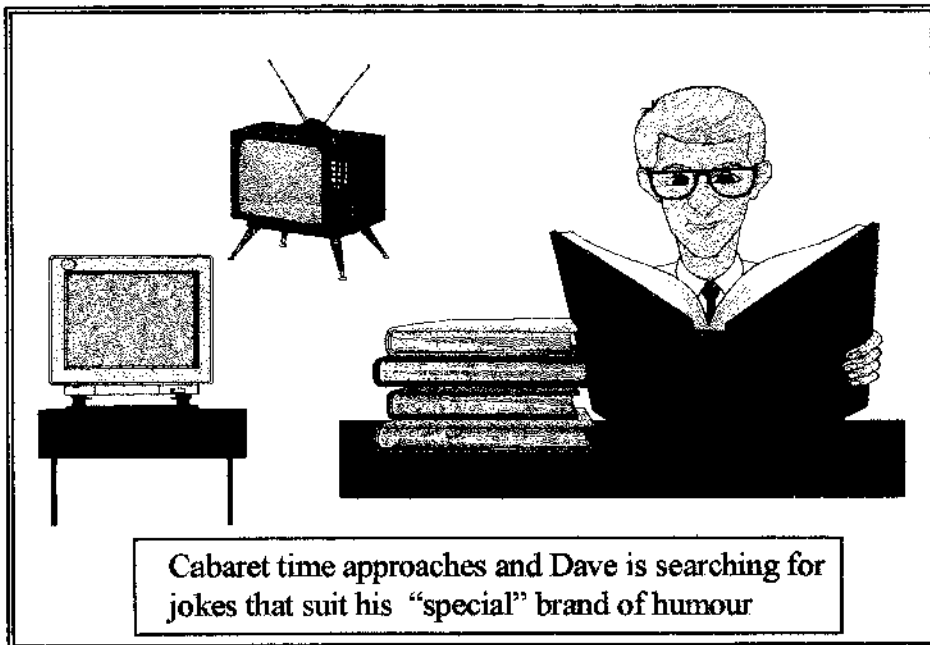

**FRIENDLY
SERVICE**



BACK PAGE THE CHRONICLE

FLACKWELL ELECTRONICS

OF CHURCH FARM, ASTON ABBOTTS

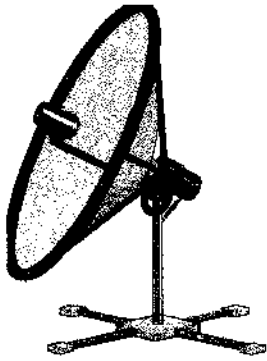

**T.V. VIDEO AND
SATELLITE
SERVICING AND
GENERAL REPAIR**

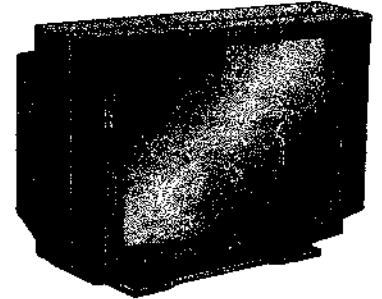

**RENTALS, NEW
AND USED SALES**

**MOST MAKES
REPAIRED
THE SAME
DAY**



**NO CALL OUT
FEE WITHIN
ASTON
ABBOTTS**

**PHONE DAVE LEWIS
ON 01296 682126**

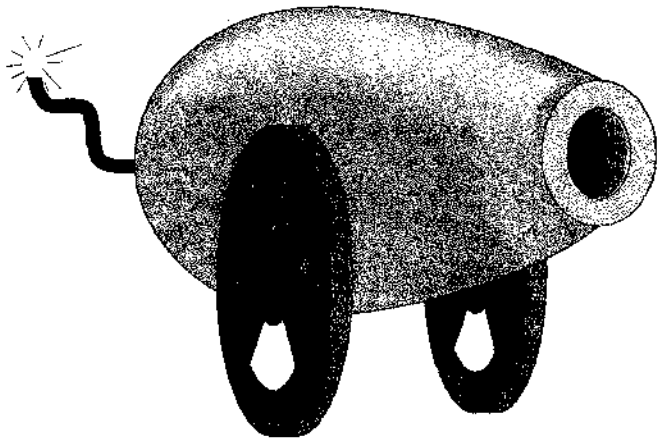

Dave's method of bowling at the 630 club 10 pin bowling evening falls foul of the house rules at Xscape.

**FRIENDLY
SERVICE**

DLT



**The Aston Abbotts
Music Maestro**

BACK PAGE THE CHRONICLE

FLACKWELL ELECTRONICS

OF CHURCH FARM, ASTON ABBOTTS

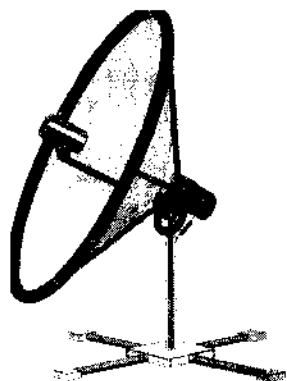

**T.V. VIDEO AND
SATELLITE
SERVICING AND
GENERAL REPAIR**

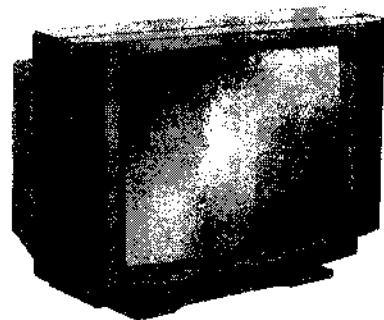

**RENTALS, NEW
AND USED SALES**

**MOST MAKES
REPAIRED
THE SAME
DAY**



**NO CALL OUT
FEE WITHIN
ASTON
ABBOTTS**

**PHONE DAVE LEWIS
ON 01296 682126**



**FRIENDLY
SERVICE**



BACK PAGE THE CHRONICLE

FLACKWELL ELECTRONICS

OF CHURCH FARM, ASTON ABBOTTS

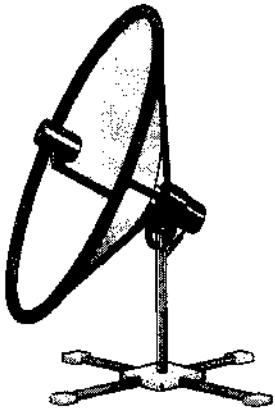

**T.V. VIDEO AND
SATELLITE
SERVICING AND
GENERAL REPAIR**

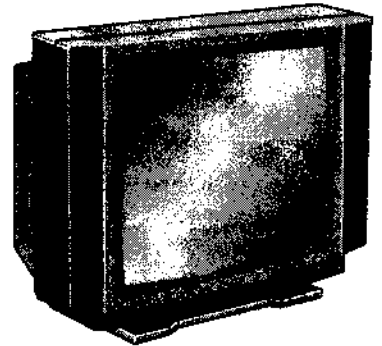

**RENTALS, NEW
AND USED SALES**

**MOST MAKES
REPAIRED
THE SAME
DAY**



**NO CALL OUT
FEE WITHIN
ASTON
ABBOTTS**

**PHONE DAVE LEWIS
ON 01296 682126**



630 Club Christmas Dinner, Royal Oak, December 2000
Dave on a mission to impress the regulars of the Oak.

**FRIENDLY
SERVICE**



FLACKWELL ELECTRONICS

OF CHURCH FARM, ASTON ABBOTTS

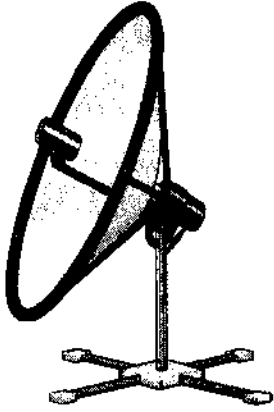

**T.V. VIDEO AND
SATELLITE
SERVICING AND
GENERAL REPAIR**

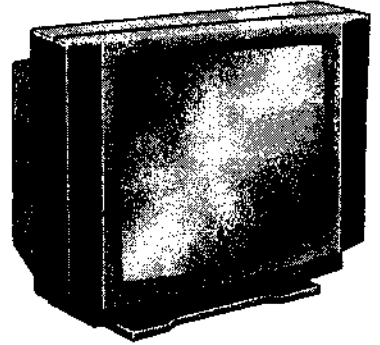

**RENTALS, NEW
AND USED SALES**

**MOST MAKES
REPAIRED
THE SAME
DAY**



**NO CALL OUT
FEE WITHIN
ASTON
ABBOTTS**

**PHONE DAVE LEWIS
ON 01296 682126**

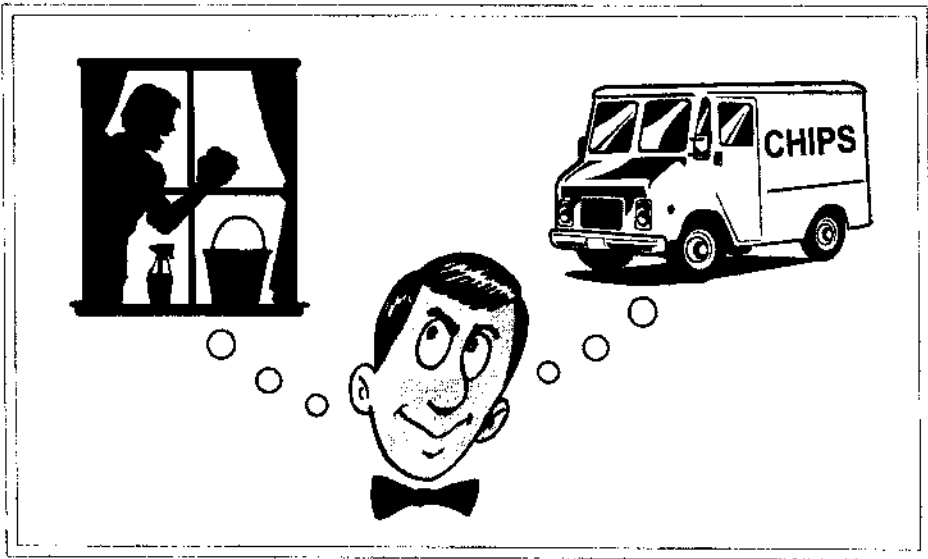

**FRIENDLY
SERVICE**



FLACKWELL ELECTRONICS

OF CHURCH FARM, ASTON ABBOTTS

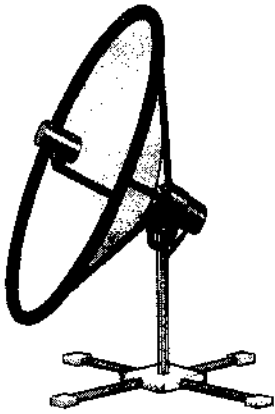

**T.V. VIDEO AND
SATELLITE
SERVICING AND
GENERAL REPAIR**

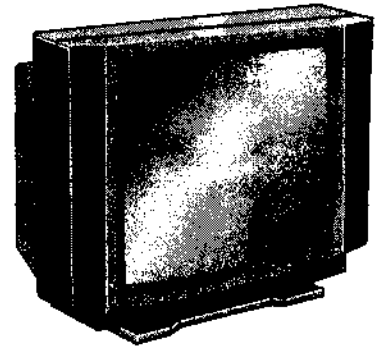

**RENTALS, NEW
AND USED SALES**

**MOST MAKES
REPAIRED
THE SAME
DAY**

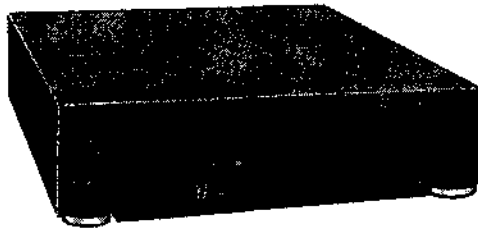

**NO CALL OUT
FEE WITHIN
ASTON
ABBOTTS**

**PHONE DAVE LEWIS
ON 01296 682126**

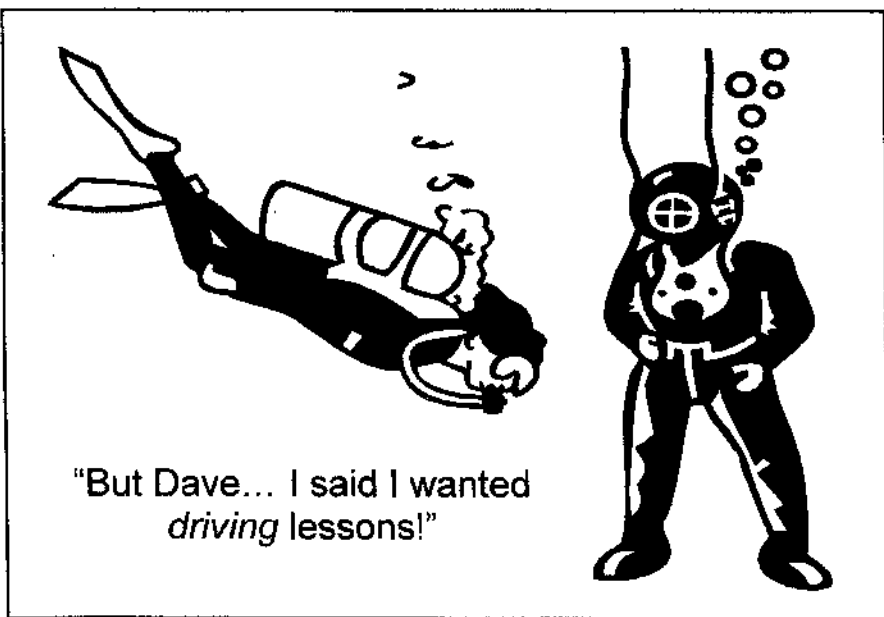

**FRIENDLY
SERVICE**



FLACKWELL ELECTRONICS

OF CHURCH FARM, ASTON ABBOTTS

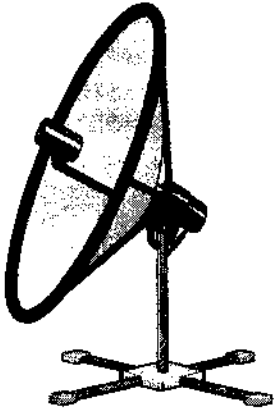

**T.V. VIDEO AND
SATELLITE
SERVICING AND
GENERAL REPAIR**

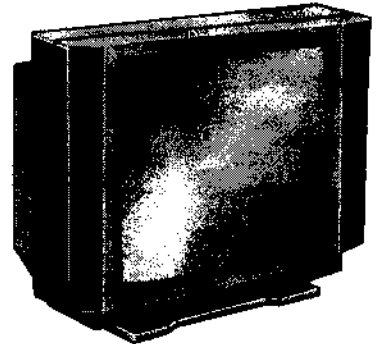

**RENTALS, NEW
AND USED SALES**

**MOST MAKES
REPAIRED
THE SAME
DAY**



**NO CALL OUT
FEE WITHIN
ASTON
ABBOTTS**

**PHONE DAVE LEWIS
ON 01296 682126**

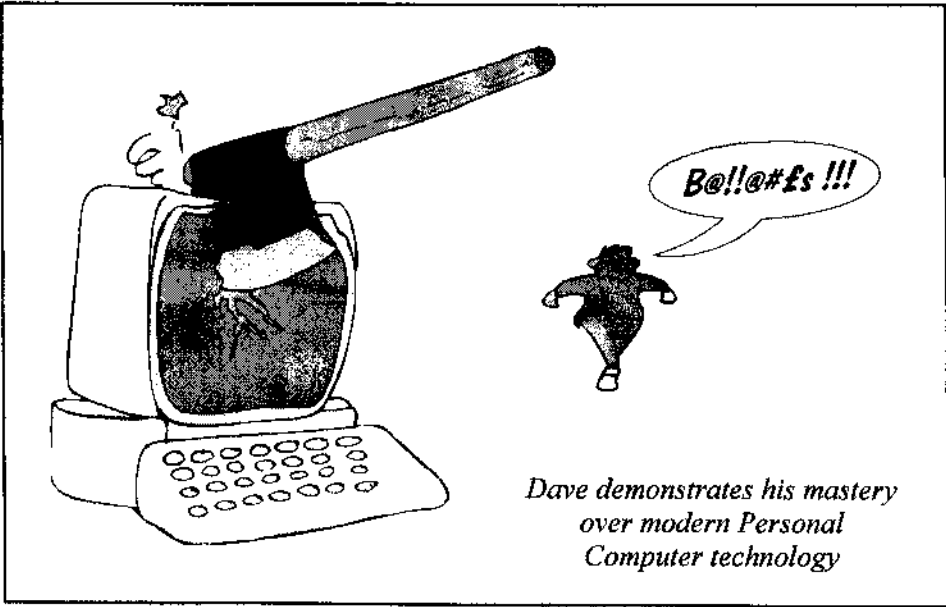

**FRIENDLY
SERVICE**



FLACKWELL ELECTRONICS

OF CHURCH FARM, ASTON ABBOTTS

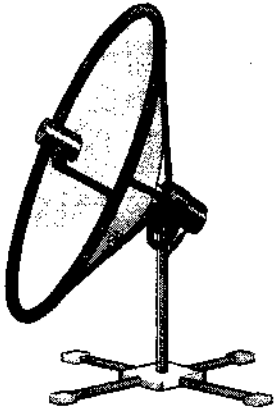

**T.V. VIDEO AND
SATELLITE
SERVICING AND
GENERAL REPAIR**

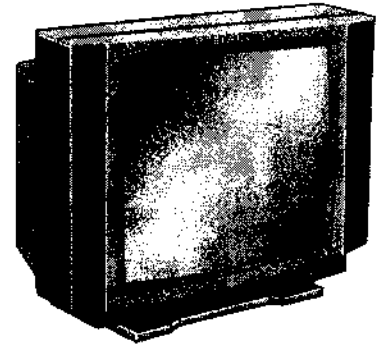

**RENTALS, NEW
AND USED SALES**

**MOST MAKES
REPAIRED
THE SAME
DAY**



**NO CALL OUT
FEE WITHIN
ASTON
ABBOTTS**

**PHONE DAVE LEWIS
ON 01296 682126**

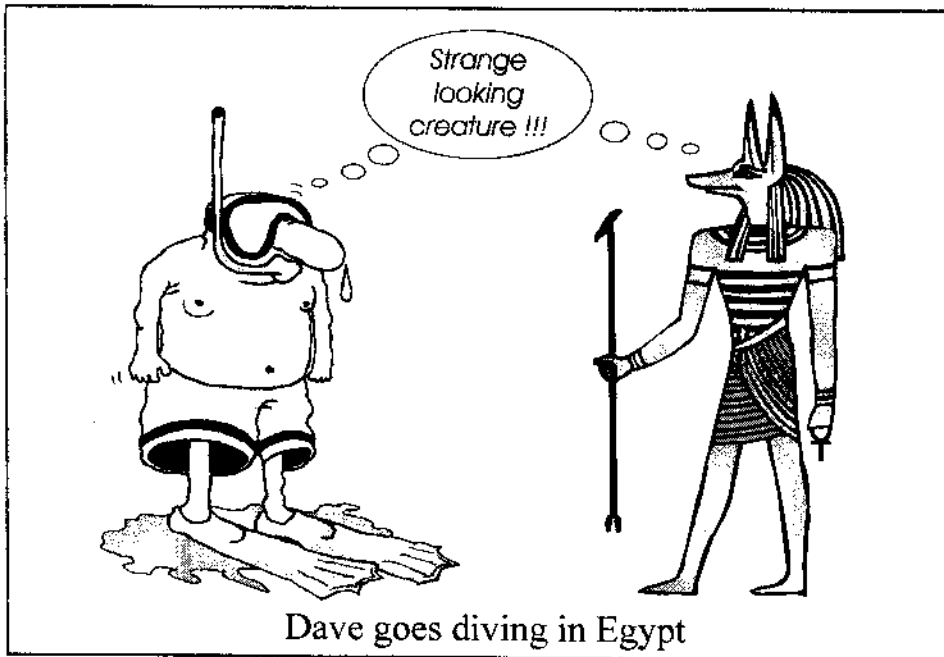

**FRIENDLY
SERVICE**



FLACKWELL ELECTRONICS

OF CHURCH FARM, ASTON ABBOTTS

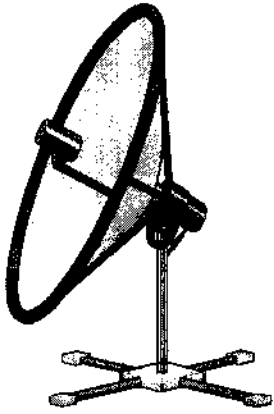

**T.V. VIDEO AND
SATELLITE
SERVICING AND
GENERAL REPAIR**

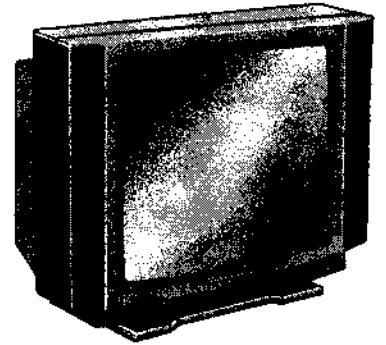

**RENTALS, NEW
AND USED SALES**

**MOST MAKES
REPAIRED
THE SAME
DAY**

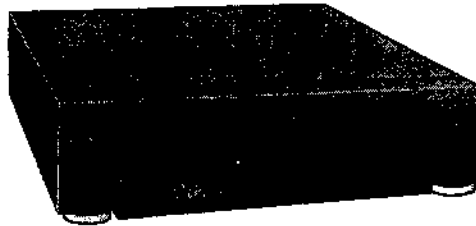

**NO CALL OUT
FEE WITHIN
ASTON
ABBOTTS**

**PHONE DAVE LEWIS
ON 01296 682126**

BEFORE

AFTER

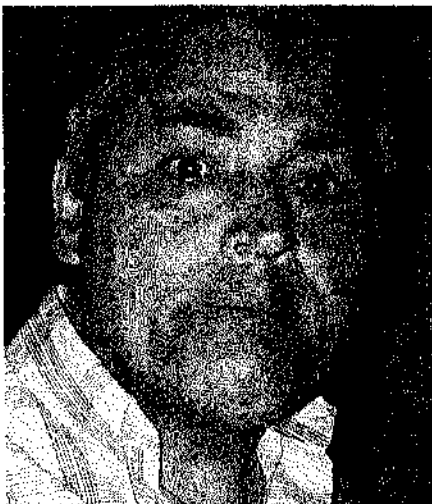

Dave enjoys the Chronicle Party

**FRIENDLY
SERVICE**



FLACKWELL ELECTRONICS

OF CHURCH FARM, ASTON ABBOTTS

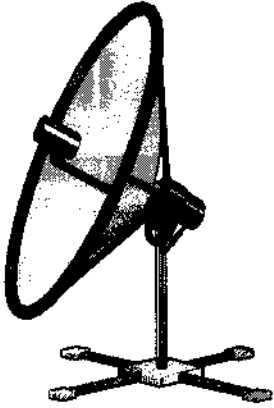

**T.V. VIDEO AND
SATELLITE
SERVICING AND
GENERAL REPAIR**

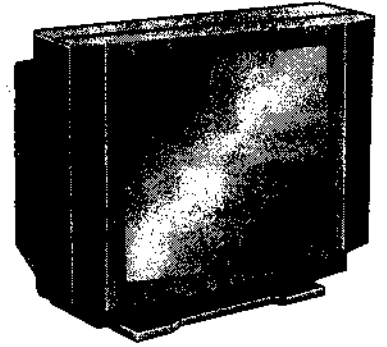

**RENTALS, NEW
AND USED SALES**

**MOST MAKES
REPAIRED
THE SAME
DAY**



**NO CALL OUT
FEE WITHIN
ASTON
ABBOTTS**

**PHONE DAVE LEWIS
ON 01296 682126**

"RENT"
PLAY
OF THE WEEK

Alison takes Dave to the theatre

**FRIENDLY
SERVICE**

**SPECIAL
ANTIQUE
HANDLING
EXPERIENCE**

FLACKWELL ELECTRONICS

OF CHURCH FARM, ASTON ABBOTTS

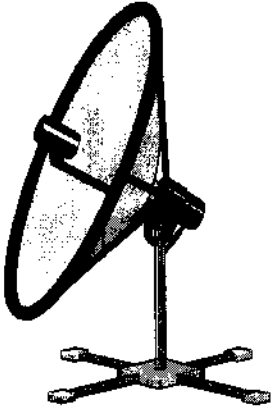

**T.V. VIDEO AND
SATELLITE
SERVICING AND
GENERAL REPAIR**

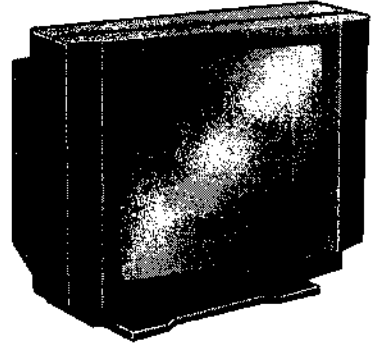

**RENTALS, NEW
AND USED SALES**

**MOST MAKES
REPAIRED
THE SAME
DAY**

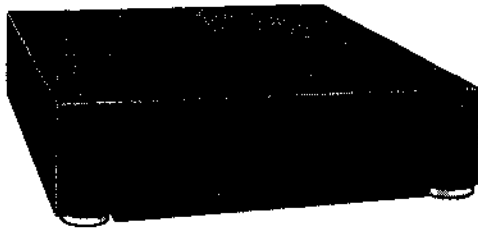

**NO CALL OUT
FEE WITHIN
ASTON
ABBOTTS**

**PHONE DAVE LEWIS
ON 01296 682126**

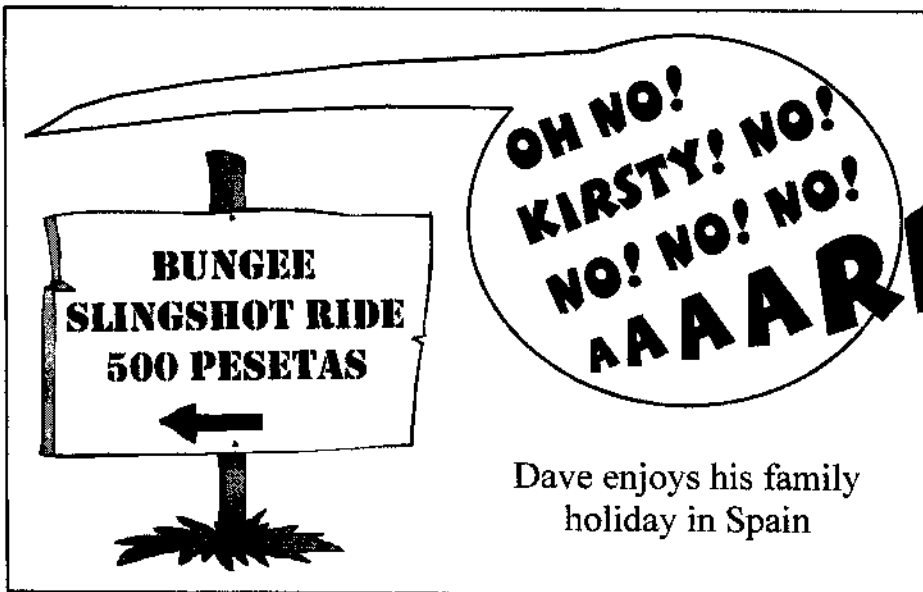

FLACKWELL ELECTRONICS

OF CHURCH FARM, ASTON ABBOTTS

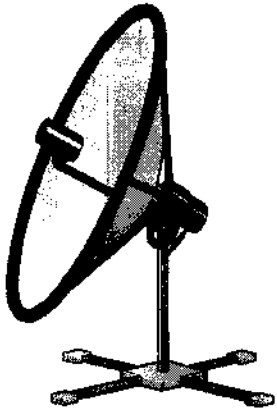

**T.V. VIDEO AND
SATELLITE
SERVICING AND
GENERAL REPAIR**

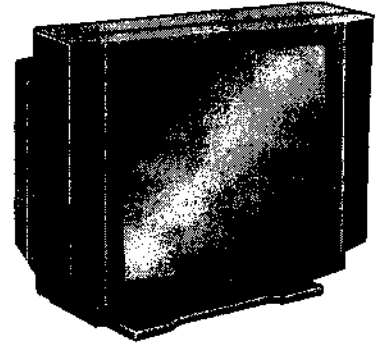

**RENTALS, NEW
AND USED SALES**



**MOST MAKES
REPAIRED
THE SAME
DAY**

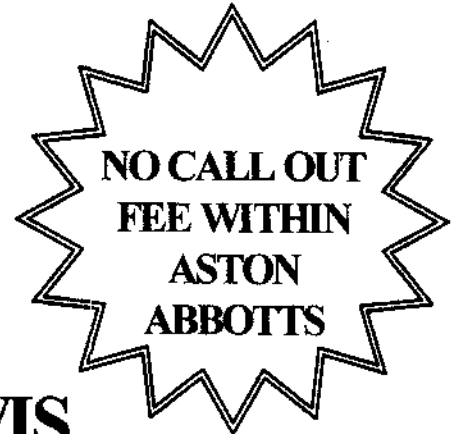

**NO CALL OUT
FEE WITHIN
ASTON
ABBOTTS**

**PHONE DAVE LEWIS
ON 01296 682126**

Dave Starts the Aston Abbots 6 Metre Diving Club

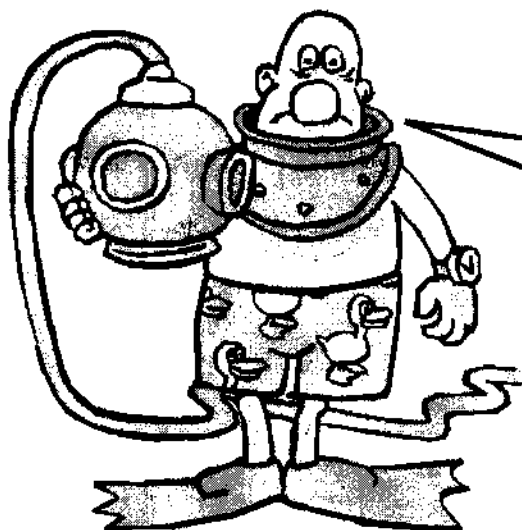

*We go
down on any
old wreck!*

**FRIENDLY
SERVICE**



FLACKWELL ELECTRONICS

OF CHURCH FARM, ASTON ABBOTTS

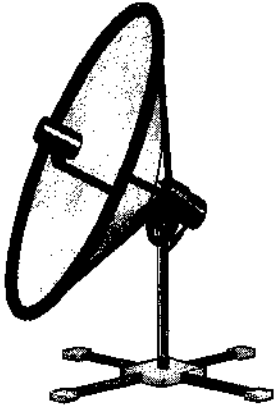

**T.V. VIDEO AND
SATELLITE
SERVICING AND
GENERAL REPAIR**

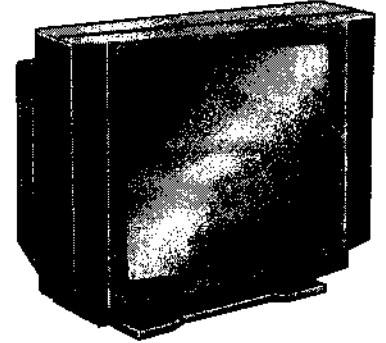

**RENTALS, NEW
AND USED SALES**



**MOST MAKES
REPAIRED
THE SAME
DAY**

**NO CALL OUT
FEE WITHIN
ASTON
ABBOTTS**

**PHONE DAVE LEWIS
ON 01296 682126**

David!
Daaviiid!!!
Who's this girl
in the green
bikini in these
Torremelinos
photos??????

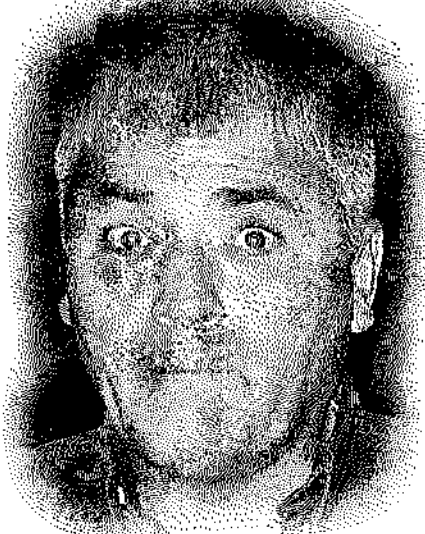

**FRIENDLY
SERVICE**



FLACKWELL ELECTRONICS

OF CHURCH FARM, ASTON ABBOTTS

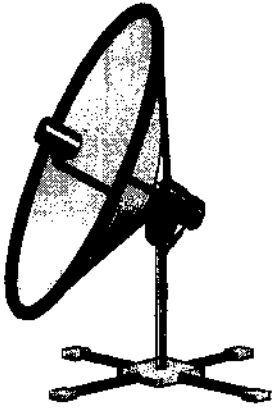

**T.V. VIDEO AND
SATELLITE
SERVICING AND
GENERAL REPAIR**

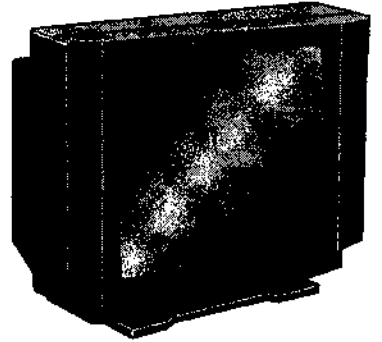

**RENTALS, NEW
AND USED SALES**

**MOST MAKES
REPAIRED
THE SAME
DAY**



**NO CALL OUT
FEE WITHIN
ASTON
ABBOTTS**

**PHONE DAVE LEWIS
ON 01296 682126**

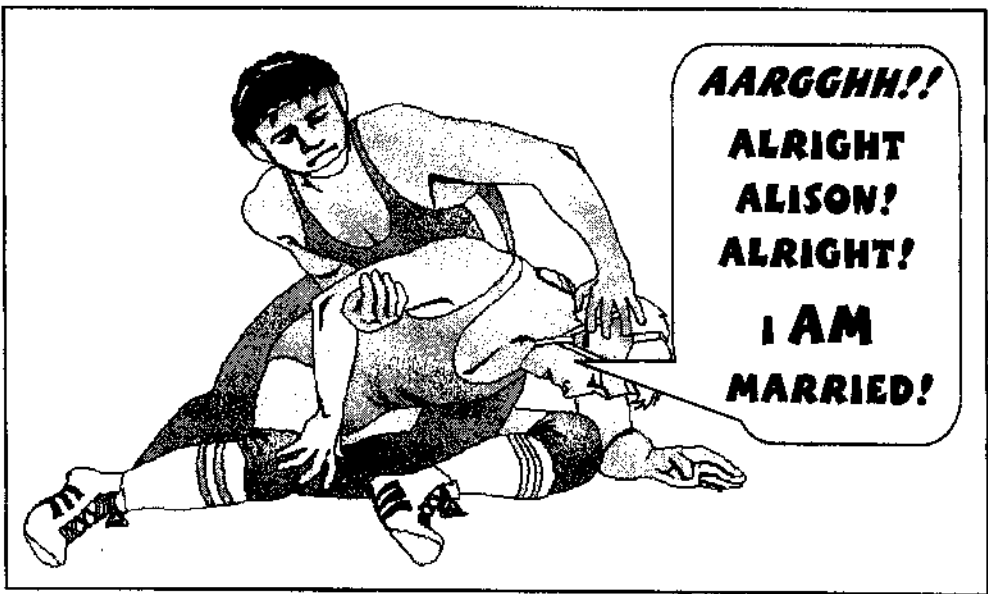

**FRIENDLY
SERVICE**



FLACKWELL ELECTRONICS

OF CHURCH FARM, ASTON ABBOTTS

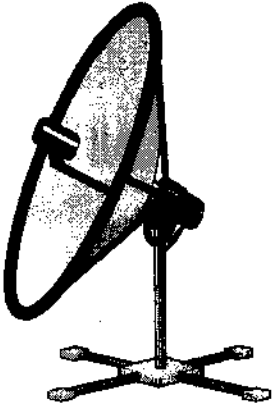

T.V. VIDEO AND
SATELLITE
SERVICING AND
GENERAL REPAIR

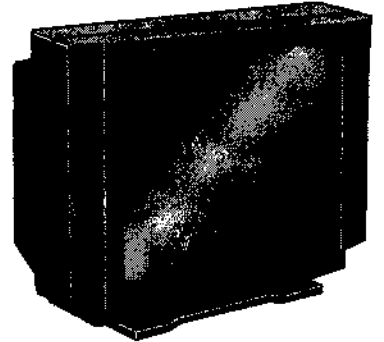

RENTALS, NEW
AND USED SALES



**LOOK 'ERE YOU LOT!
I DON'T WANT NONE
OF YOU BUZZARDS
TALKING ABOUT
WHAT MY MISSUS
EARNS. IT'S NONE
OF YER BLEEPING
BUSINESS. GOT
THAT? 'RIGHT!**

**DAVE LEWIS
01296 682126**

FLACKWELL ELECTRONICS

OF CHURCH FARM, ASTON ABBOTTS

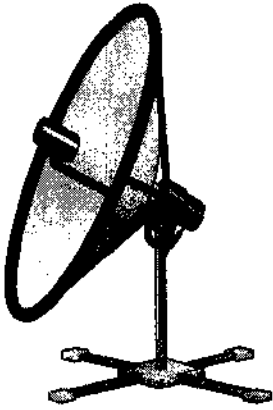

**T.V. VIDEO AND
SATELLITE
SERVICING AND
GENERAL REPAIR**

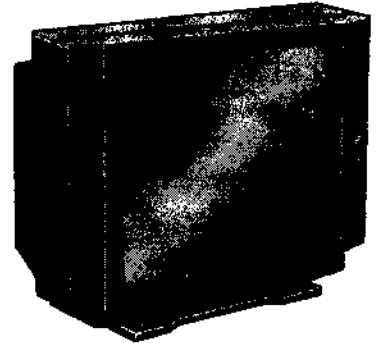

**RENTALS, NEW
AND USED SALES**

**MOST MAKES
REPAIRED
THE SAME
DAY**



**NO CALL OUT
FEE WITHIN
ASTON
ABBOTTS**

**PHONE DAVE LEWIS
ON 01296 682126**



CAR BODY REPAIRS FLACKWELL ~~ELECTRONICS~~

OF CHURCH FARM, ASTON ABBOTTS

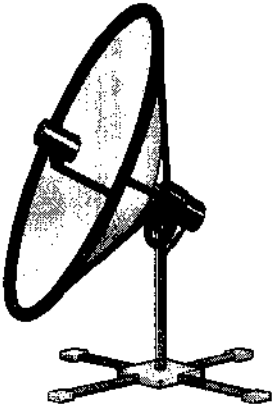

**WE CAN REMOVE
ALL SORTS OF
DENTS FROM ANY
MAKE OF CAR**

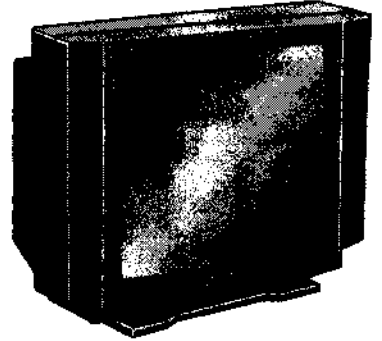

***MONEY IS OFTEN
NOT REQUIRED—WE
JUST LIKE DOING IT!***



**MOST MAKES
REPAIRED
THE SAME
DAY**

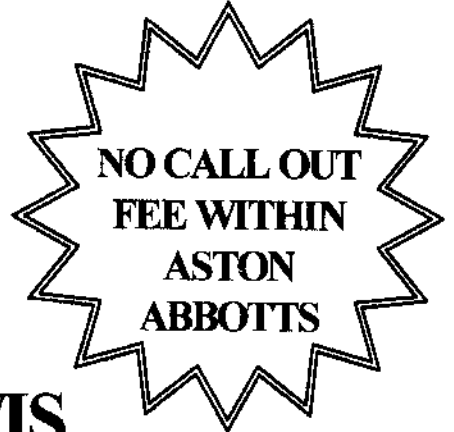

**NO CALL OUT
FEE WITHIN
ASTON
ABBOTTS**

**PHONE DAVE LEWIS
ON 01296 682126**

Feb 14th 2002: Mystery lovers seen holding hands in the road near the Old Masters

I wonder
if I can manage
desert?

I wonder
if he still loves
me?

I wonder
what he's thinking
right now?



I wonder
if I can get finished
here before the
pubs close?

FLACKWELL FLIGHTS OF CHURCH FARM, ASTON ABBOTTS



"In 1996 I had a dream. This exciting new venture is the realisation of that dream.

"My dream started to become a reality when I had helicopter lessons last year. Then in January the helipad licence for Church Farm was finally issued.

"Now I am proud to offer this new short-haul helicopter shuttle service for Aston Abbots. I will be happy to quote for any charter flights or special requirements. My chopper is always ready—Just give me a call."

Dave Lewis

CHURCH FARM HELIPAD FLIGHT SCHEDULES 2002

Weekdays (Mon—Fri)

07.45 AA to Cheddington Station (BR)
 08.15 AA to Cottlesloe School
 08.30 AA to Wingrave School
 09.10 AA to Tesco Aylesbury and Friars Square (FS not Mondays)
 09.35 AA to Waitrose Leighton Buzzard
 10.10 AA to Tesco Aylesbury
 11.10 Tesco Aylesbury to AA
 11.45 Waitrose Leighton Buzzard to AA
 15.00 Friars Square to AA (not Mondays)
 15.40 Cottlesloe School to AA
 15.55 Wingrave School to AA
 18.45 Cheddington Station (BR) to AA
 19.55 Cheddington Station (BR) to AA

Weekends and Bank Holidays

09.15 AA to Cheddington Station (BR)
 09.45 AA to Wendover Station (BR)
 10.30 AA to Cheddington Station (BR)
 11.10 AA to Tesco Aylesbury
 11.35 AA to Friars Square
 09.35 AA to Waitrose Leighton Buzzard
 10.10 AA to Tesco Aylesbury
 12.05 Tesco Aylesbury to AA
 18.30 Bull and Butcher shuttle (Sats only)
 18.45 Cheddington Station (BR) to AA
 19.05 Wendover Station (BR) to AA
 19.30 Bull and Butcher shuttle (Sats only)
 23.55 Cheddington Station (BR) to AA (Sats and advance booking only)

CAA Operating Licence Number CA075531/DLCF6 FCC Insurance Certificate 5BL-6662C

THE SMALL PRINT

- All flights are subject to cancellation if weather conditions are poor.
- Flights to/from Cublington are subject to the Cublington Parish Council's £5 per passenger landing fee.
- Seats subject to availability & must be pre-booked 24 hours in advance. We accept all sensible major currencies. Euros not accepted.
- Goods purchased on shopping trips outside of Aston Abbots Parish boundary will be subject to HM Customs import duty - cheques payable to J Whyte please.
- Low-cost midwifery service available on maternity runs to local hospitals.
- For security reasons female passengers may be subjected to a full body search by the 630 club
- Alpacas must pay the full fare price unless they sit on the lap of an accompanying adult.
- This schedule commences April 1st 2002 and runs until 12 noon on that same day.
- We also repair TVs, videos and satellite equipment. Most makes repaired the same day. No call-out fee within Aston Abbots.

PHONE DAVE LEWIS ON 01296 682126

Happy Birthday

Alison

Love
Dave
(Signature)

A Great Big Thank You

Alison and I wish to convey A Big Thank You to everyone in the village who contributed to her 50th birthday present and made the day so special.

I also send great thanks to Francesca for providing such a terrific spread of food and managing all things catering.

Clare for spending many hours on the decorations and their setting up.

Deirdre, Bridget & Anne for providing some of the food dishes.

Lol for making the evening rock.

Also the last minute helpers who on the day saved me from the last minute dash to the shops. I'll keep your names out as Alison thinks I managed all the rest by myself, and you know who you are.

Lastly thanks to you all for coming and making the evening one we shall never forget.

Dave Lewis

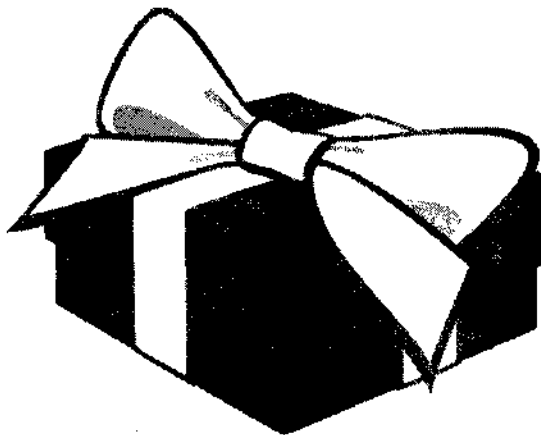

**FLACKWELL
ELECTRONICS
01296 682126**

FLACKWELL ELECTRONICS

OF CHURCH FARM, ASTON ABBOTTS

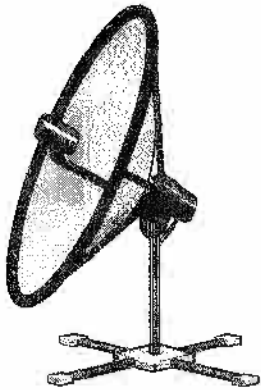

**T.V. VIDEO AND
SATELLITE
SERVICING AND
GENERAL REPAIR**

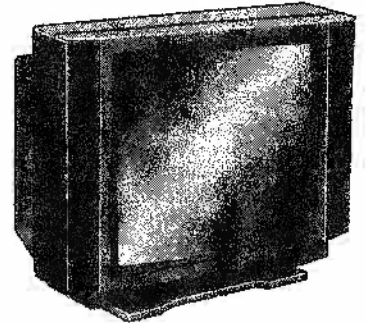

**RENTALS, NEW
AND USED SALES**

**MOST MAKES
REPAIRED
THE SAME
DAY**

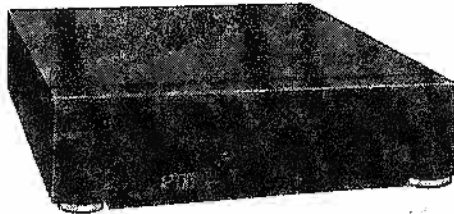

**NO CALL OUT
FEE WITHIN
ASTON
ABBOTTS**

**PHONE DAVE LEWIS
ON 01296 682126**

Where's
Dave? I can't
find Dave
anywhere!
Does anybody
know what my
husband's
doing?



FLACKWELL ELECTRONICS

OF CHURCH FARM, ASTON ABBOTTS

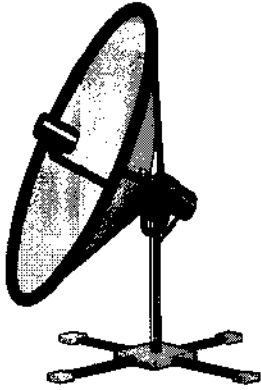

**T.V. VIDEO AND
SATELLITE
SERVICING AND
GENERAL REPAIR**

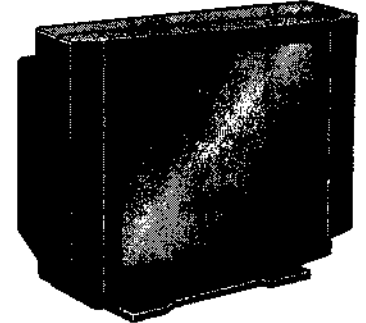

**RENTALS, NEW
AND USED SALES**

**MOST MAKES
REPAIRED
THE SAME
DAY**



**NO CALL OUT
FEE WITHIN
ASTON
ABBOTTS**

**PHONE DAVE LEWIS
ON 01296 682126**

STOP PRESS!

ALISON LEWIS RETIRES TO LOOK AFTER HOUSE AND HOME

David! The grass needs cutting!

David! Don't forget to pick Kirsty up!

David! Can you pop into Tesco's

David! Why do people shout " 'Allo to sexy" as I drive past?

David! Don't forget to feed the chickens!

David! Can you fetch my new book!

David! Don't be silly—you haven't got time to go down the pub!

David? David? Where's David?

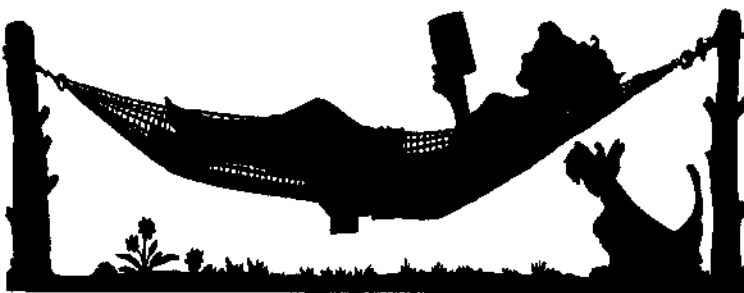

FLACKWELL ELECTRONICS

OF CHURCH FARM, ASTON ABBOTTS

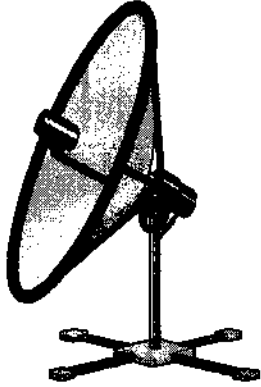

**T.V. VIDEO AND
SATELLITE
SERVICING AND
GENERAL REPAIR**

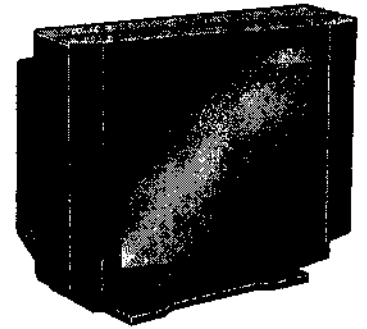

**RENTALS, NEW
AND USED SALES**

**MOST MAKES
REPAIRED
THE SAME
DAY**



**NO CALL OUT
FEE WITHIN
ASTON
ABBOTTS**

**PHONE DAVE LEWIS
ON 01296 682126**

THE ALISON LEWIS CAR CLEANING GUIDE

INSTRUCTIONS: Just combine the following three items in close proximity to your new Toyota RAV4 and all of your car cleaning problems will be over !!

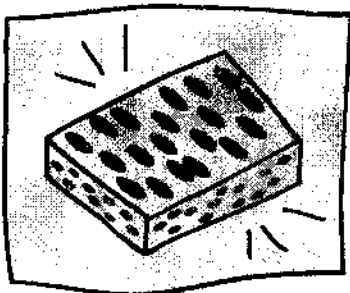

1. SPONGE



2. SOAPY WATER

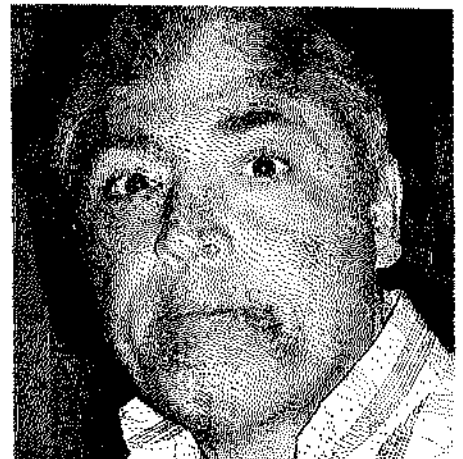

3. MUG !!!

FLACKWELL ELECTRONICS

CHURCH FARM, ASTON ABBOTTS Tel: 01296 682126

OUTRAGE OVER NEW FLIGHTPATH PROPOSAL

Luton residents reacted angrily this week to news of a proposed new direct descent flightpath in to Aston Abbots. This new flight approach could see David Lewis passing directly over Luton town at low altitude in a desperate attempt to locate Church Farm.

Protestors were quick to point out that the new flightpath might see landings at Church Farm increase from the current 0.000002 mppa (million passengers per annum). They are also upset that nighttime flights home may disturb their sleep. "He can be very late coming home on a Friday night," one protestor told us, "and he *sings!*"

A spokesman for Luton backed the protests, saying, "This town is just so peaceful at night - all you can hear are the town sounds of glass breaking and car alarms going off", and added, "We don't want that pest over us!"

Luton residents have vowed to fight the application. A protest group - the Bedfordshire Against Lewis' Landings Society - has been formed. Members deny they are being nimbys, telling us, "Just keep that pest away from us!"

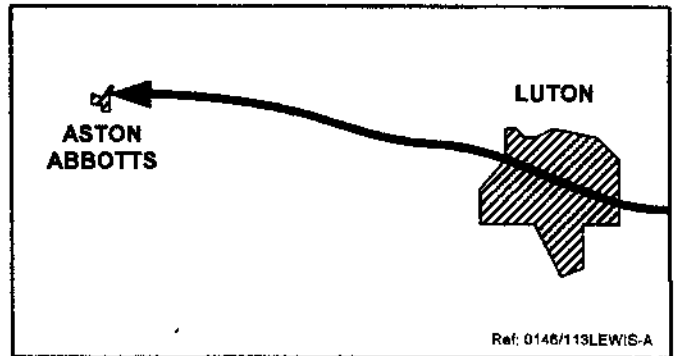

Lewis' proposed new approach flightpath to Aston Abbots

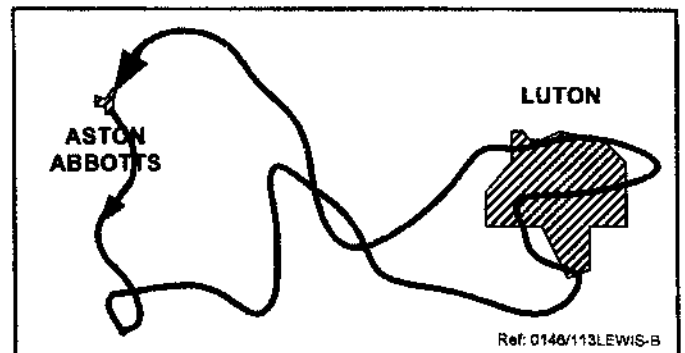

The alternative Lewis approach flightpath to be used on Friday nights after closing time

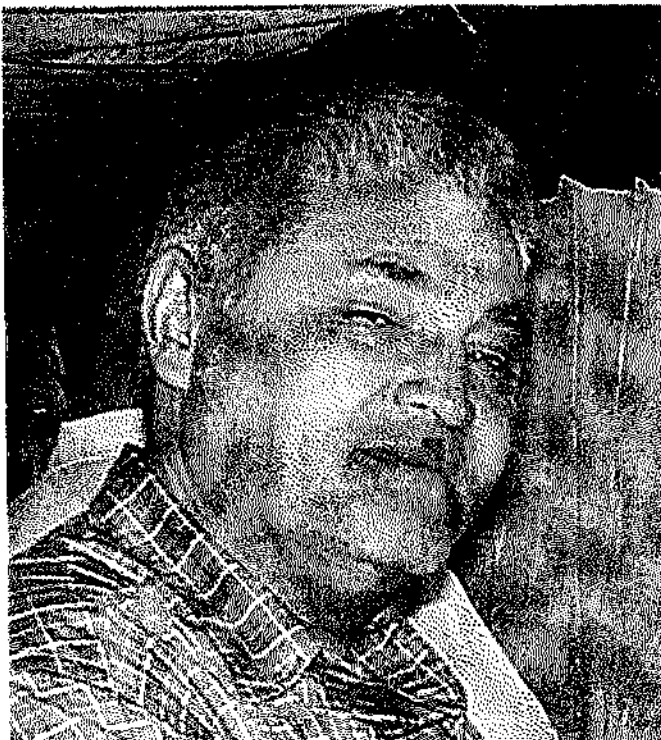

Lewis "...pest..."

Meanwhile support for the new flight path has been growing in Aston Abbots. Lewis' friend John Whyte a few days ago launched a support group with great enthusiasm and has, typically, been talking nothing but excitable Bucks Official Lewis' Landings Organisation and Complete Kamikaze Support ever since

Whyte has also been quick to deny that the application does not reveal the true low height nature of the flights. Whilst admitting that the planned height of 250 foot is actually above sea level he was unable to confirm that Aston Abbots' greater height of 450 feet a.s.l. could see the last three miles of the approach being 200 foot below ground, commenting tartly, "Such an approach is quite normal for a Lewis landing".

~ Aviation Correspondent

EYELASH PERMING? - JUST ASK

FLACKWELL ELECTRONICS

OF CHURCH FARM, ASTON ABBOTTS

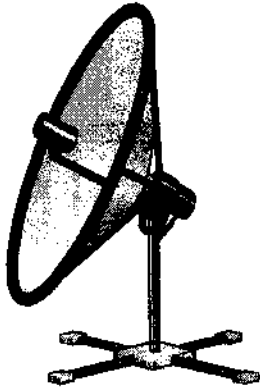

**T.V. VIDEO AND
SATELLITE
SERVICING AND
GENERAL REPAIR**

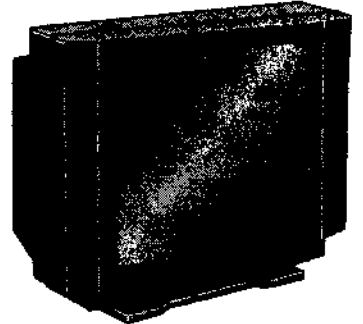

**RENTALS, NEW
AND USED SALES**



**MOST MAKES
REPAIRED
THE SAME
DAY**



**NO CALL OUT
FEE WITHIN
ASTON
ABBOTTS**

**PHONE DAVE LEWIS
ON 01296 682126**

BURGLAR ON THE ROOF?

Do you have troubles with burglars on the roof—tapping on the tiles? We offer a rapid response service.

- ✦ Households Protected
- ✦ Lofts Inspected
- ✦ Roofs ruminated over
- ✦ Lives laid down
- ✦ No self-sacrifice too large.

Next time you hear a tapping in the loft just phone the pub and Dave will abandon his beer and come **RUNNING**.

We also do Lurkers in the Loft, Criminals in the Closet and Gypsies in the Jacuzzi. (and Anarchists in the Annexe, by special arrangement only)

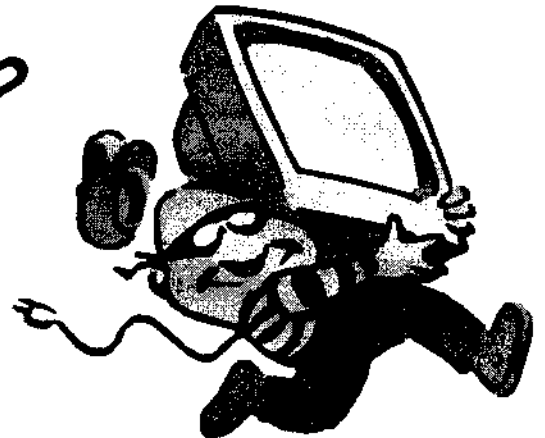

Classified

FOR SALE: ENCYCLOPAEDIA ALISONICA. Knows everything. Tells you what you need to know, whether you want to know it or not. Never wrong - always right. Fitted with large audio output socket. Apply D Lewis. No offer refused.

FLACKWELL ELECTRONICS

CHURCH FARM, ASTON ABBOTTS Tel: 01296 682126

DAVE LEWIS LOSES HIS SHIRT !!!

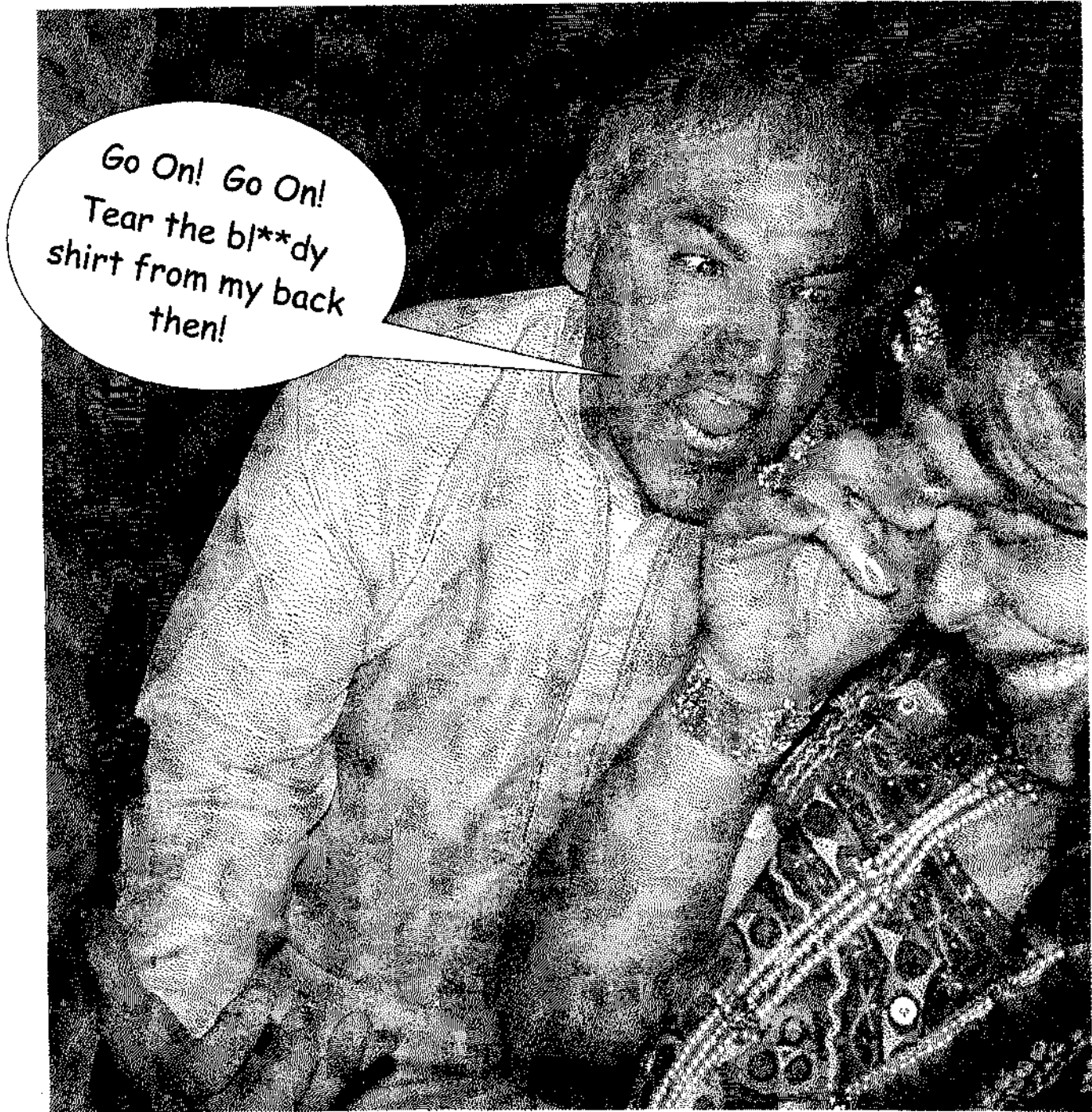

A furious and frustrated Dave Lewis remonstrates with 'banker' Poonam Gupta after losing his shirt, his house, his car, his wife's car and his wife - not once, not twice, but THREE TIMES on sure-fire no-lose hands of cards whilst playing Jackpot at the Diwali celebration on November the 2nd.

FLACKWELL ELECTRONICS

CHURCH FARM, ASTON ABBOTTS Tel: 01296 682126

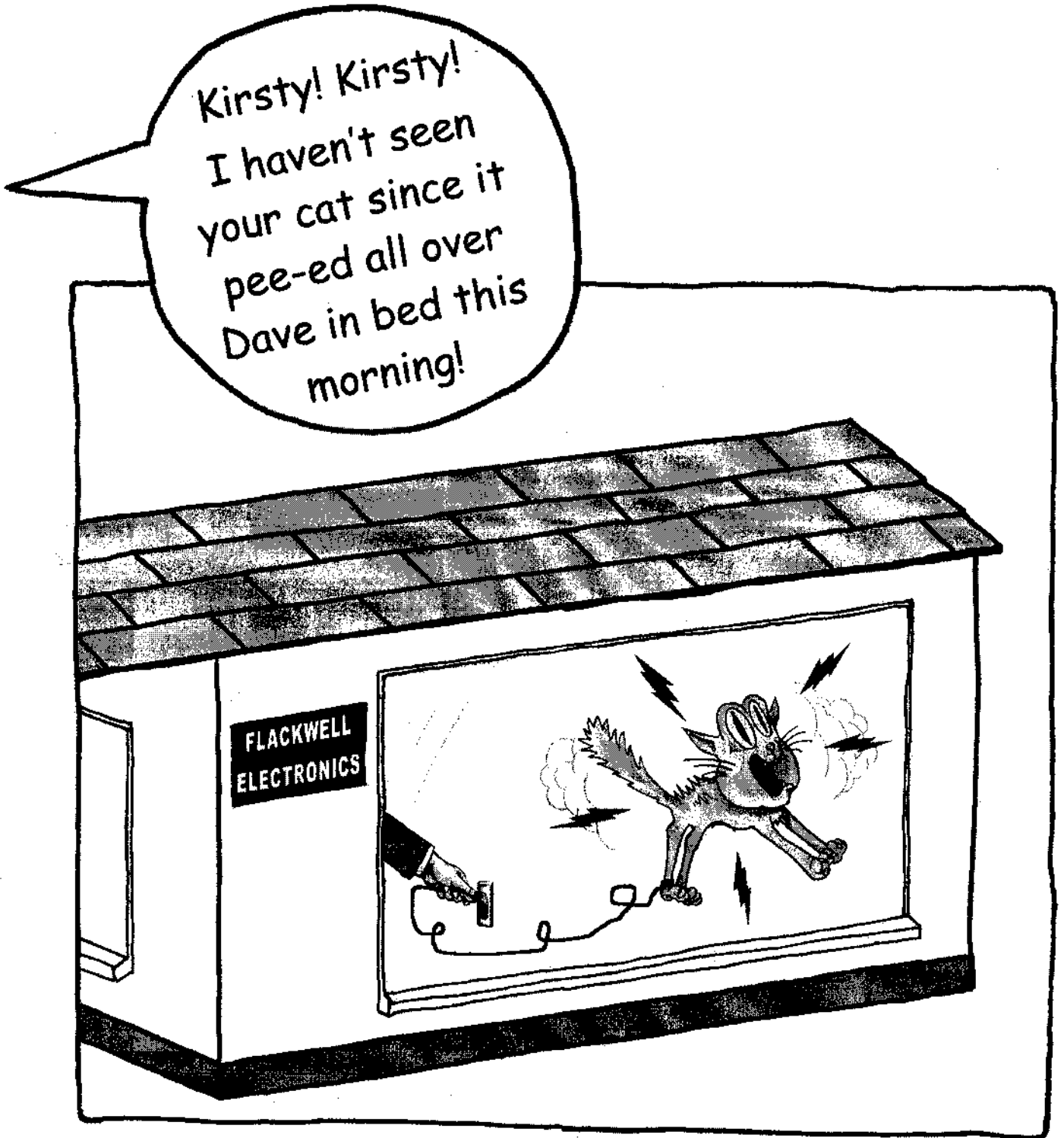

We wish to assure readers that no actual animal was harmed during the making of this advertisement

FLACKWELL ELECTRONICS

CHURCH FARM, ASTON ABBOTTS Tel: 01296 682126



The Chronicle reveals all! You know what turns Dave on! But just who is this mystery woman trying to lead our Dave astray? Drawn irresistibly... like a moth to a flame... like a donkey to a carrot... like a 630 club member to a beer... poor Dave has eyes only for ~~two~~ one things... our Dave just cannot resist the lure of a miniature bottle of Baileys. He'll go anywhere... do anything for a ~~te~~ tippie!

FLACKWELL ELECTRONICS

CHURCH FARM, ASTON ABBOTTS Tel: 01296 682126

ARMY SURROUND CHURCH FARM

Aston Abbots residents awoke to the sound of tanks rattling along the Cublington Road as heavily armed troops surrounded Church Farm in the early hours of one morning in February.

A full scale anti-terrorist alert had been called after villagers as far afield as Cublington had reported sounds of an artillery barrage coming from Church Farm and the seismic monitoring station in Leighton Buzzard had recorded disturbances reaching 4.1 on the Richter scale.

As troops in protective clothing moved swiftly up the Wingrave Road and helicopters hovered overhead an advance reconnaissance group confirmed the nightmare scenario: Dave Lewis was snoring again.

The military set up a command post in the Old Masters, whilst the RSPCA moved rapidly to evacuate a herd of terrified alpacas from a nearby field. Meanwhile an elite specially trained squad wearing soundproof suits mounted a courageous assault to rescue Lewis' long-suffering partner Mrs Alison Lewis.

The army moved quickly to dispel rumours that they were trying to capture Dave Lewis for use in the fight against terrorism. Army spokesman Major Tim Peacocke told The Chronicle, "We have many military options acceptable

to the UN available to us, but using Dave Lewis' snoring as a weapon of mass destruction is not one of them." However a reliable military source confirmed to us that serious consideration had been given to a plan that would have seen Dave Lewis smuggled onto enemy territory, plied with several pints of lager and lime, given three double-Baileys, and then left for nature to take its course.

As the army fought desperately to get the situation under control residents did what they could to protect themselves. Within hours local entrepreneur and well-known wheeler-dealer Bernard Osborn confirmed that he had exhausted the entire national supply of Happy Shopper industrial-strength earplugs.

Whilst villagers were left reeling from this latest assault upon their safety and sanity one anonymous local resident who wished only to be known by the code name of T. Jones sprang to Lewis' defence. "It's not unusual," he said.

Aylesbury Vale District Council denied that they were slow to act in response to the problem. A spokesman told us, "We have set-up a Helpline for distressed villagers. The best thing that people can do is to ring 01296 682126 immediately and give the b****r a piece of your mind".

~ Village Correspondent



*Alison Lewis
"long-suffering"*



*Anonymous local resident
"support"*

FLACKWELL ELECTRONICS

OF CHURCH FARM, ASTON ABBOTTS

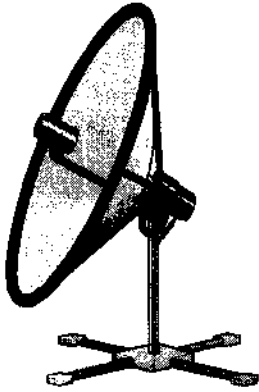

**T.V. VIDEO AND
SATELLITE
SERVICING AND
GENERAL REPAIR**

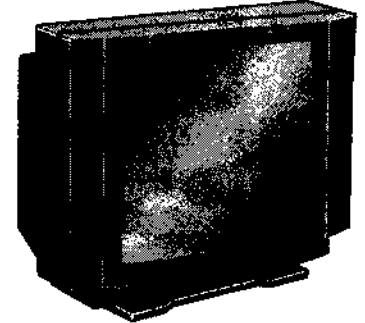

**RENTALS, NEW
AND USED SALES**

**MOST MAKES
REPAIRED
THE SAME
DAY**

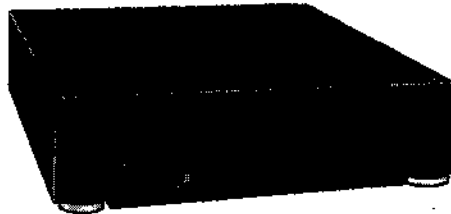

**NO CALL OUT
FEE WITHIN
ASTON
ABBOTTS**

**PHONE DAVE LEWIS
ON 01296 682126**

A holidaying Dave Lewis Dreams of his perfect Holiday Flight

*Help!! HELP!!!
The pilots had a
heart attack... The
co-pilots having a
baby... We're diving
uncontrollably into
the Indian Ocean...
IS THERE A PILOT
ON BOARD??*



**Yes!
ME!!!**

FLACKWELL ELECTRONICS

OF CHURCH FARM, ASTON ABBOTTS

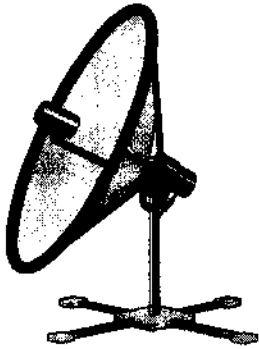

**T.V. VIDEO AND
SATELLITE
SERVICING AND
GENERAL REPAIR**

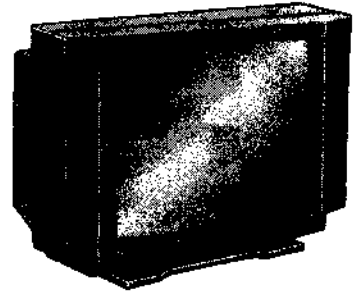

**RENTALS, NEW
AND USED SALES**

**MOST MAKES
REPAIRED
THE SAME
DAY**



**NO CALL OUT
FEE WITHIN
ASTON
ABBOTTS**

**PHONE DAVE LEWIS
ON 01296 682126**



FLACKWELL ELECTRONICS

OF CHURCH FARM, ASTON ABBOTTS

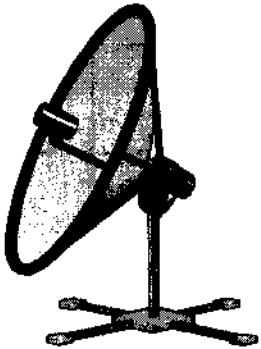

**T.V. VIDEO AND
SATELLITE
SERVICING AND
GENERAL REPAIR**

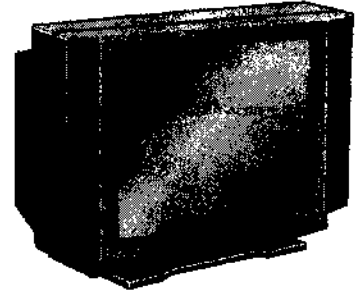

**RENTALS, NEW
AND USED SALES**

**MOST MAKES
REPAIRED
THE SAME
DAY**



**PHONE
DAVE LEWIS
ON
01296 682126**

**Nearly Useful Music Ltd present
Mr David W Lewis**

and his

Famous Plucking Finger

**who will attempt to play the bass guitar
without the benefit of safety equipment**

at

Astonbury 2003

**Saturday July 12th
(for one note only)**

Be there or be... somewhere else

Please use protection during Mr Lewis' performance. Patrons are responsible for their own safety equipment. Small children may be frightened. This performance may contain bad language, violence and/or scenes of alcohol abuse. We recommend watching the performance from a safe distance (preferably Wingrave). No refunds.

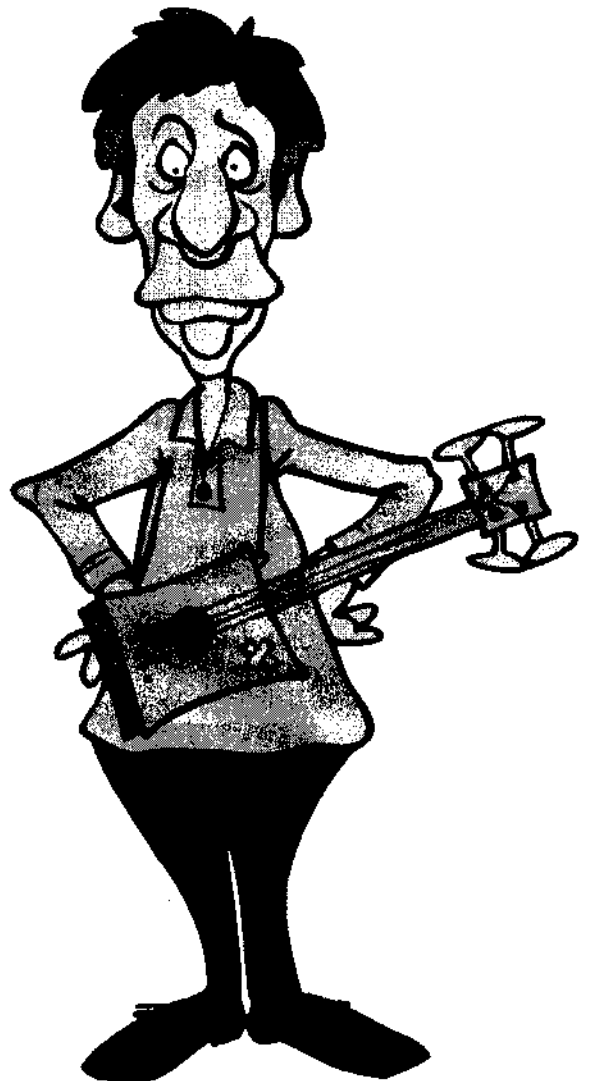

Practically Anything

Interior fixtures and fittings

Curtain tracks and cording sets

Light fitting replacements

Additional electrical sockets

Any small jobs around the home

Call Dave Lewis on 682126 and tell me
what you require

Be among the first to support Aston
Abbotts latest small business based at
Church Farm.



Practically Anything



Yes—it's our Dave! Dave will undertake any small jobs that you need to get done. Just call him on 682126, but whatever you do



...DON'T MAKE HIM ANGRY!

Image © Universal 2003. Body © D Lewis 1973

FLACKWELL ELECTRONICS

OF CHURCH FARM, ASTON ABBOTTS

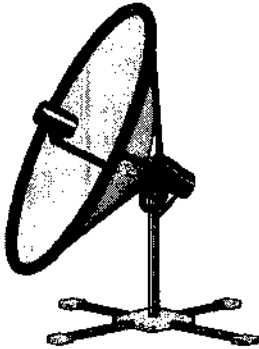

**T.V. VIDEO AND
SATELLITE
SERVICING AND
GENERAL REPAIR**

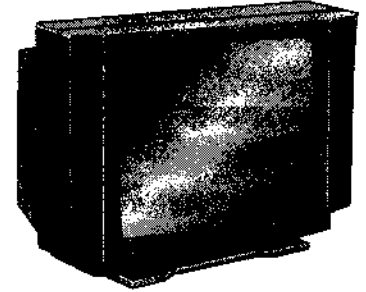

**RENTALS, NEW
AND USED SALES**

**MOST MAKES
REPAIRED
THE SAME
DAY**



**NO CALL OUT
FEE WITHIN
ASTON
ABBOTTS**

**PHONE DAVE LEWIS
ON 01296 682126**

Next month
Dave will help
with the annual
fireworks
display—just
like last
year....



FLACKWELL ELECTRONICS

OF CHURCH FARM, ASTON ABBOTTS

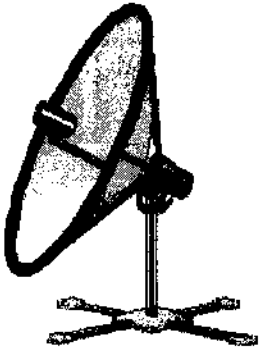

**T.V. VIDEO AND
SATELLITE
SERVICING AND
GENERAL REPAIR**

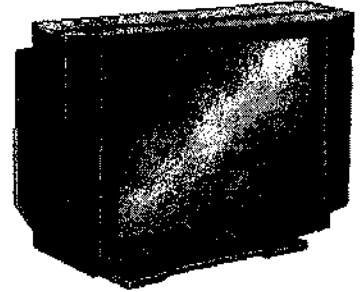

**RENTALS, NEW
AND USED SALES**

**01296
682126**



**01296
682126**



DJ Dave on Flame FM

Not 'arf!

Wow man! Here's another groovy tune from a far-out fab beat combo. It's a really swinging little number so lets have all of you cats getting down to this. Super!

Merry Christmas



Dave and Alison
wish all our friends
A Very Merry Christmas

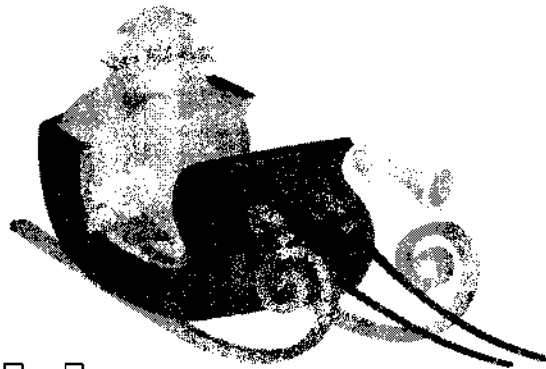

No cards this year
we will be making a donation
to charity instead

Have a great time.

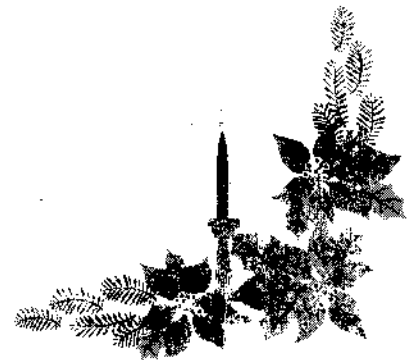

FLACKWELL ELECTRONICS

CHURCH FARM, ASTON ABBOTTS Tel: 01296 682126

DAVE LEWIS IS CERTIFIED



Yes – it's official. Dave has been certified. This momentous event happened when Dave, accompanied by three fellow experimenters, defied the laws of gravity to fly in a heavier than air machine on the 100th anniversary of flight, December 17th 2003. Leaving Wycombe Air Centre mid-morning Dave first climbed to an unbelievable height of 2000 feet and proved conclusively that he would not spontaneously combust due to flying too close to the sun. Flying up the Vale he circled Aston Abbotts and Waddesdon before impressing all on board by his uncanny ability to find his way back to High Wycombe. Unlike the Wright brothers who kept their achievement secret for several years, upon safely returning to *terra firma* Dave immediately headed for the Royal Oak where he informed a less-than-stunned crowd of two of his feat, provoking incredulous gasps of, "You nearly parted my hair" and, "Oh, I wondered who was in that plane". All crewmembers survived the experience without physical or mental injury and received certificates from the Air Centre. In addition, Dave will be certified by the CAA for his heroic achievement. Well done Dave—and Thank You from your fellow travellers.

FLACKWELL ELECTRONICS

CHURCH FARM, ASTON ABBOTTS Tel: 01296 682126



**Dave Lewis before
discovering wine,
flying and girls**



**Dave Lewis
after
discovering
wine, flying
and girls**

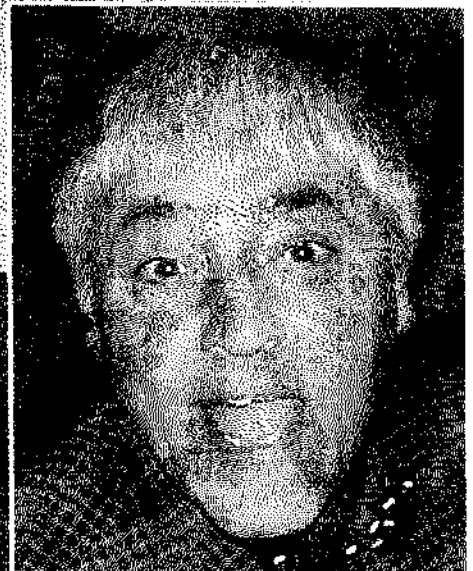

Happy 50th Birthday Dave

FLACKWELL ELECTRONICS

OF CHURCH FARM, ASTON ABBOTTS

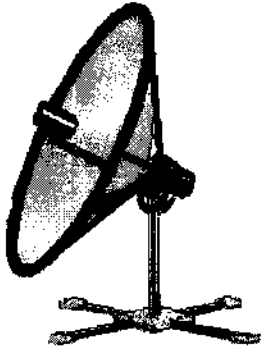

T.V. VIDEO AND
SATELLITE
SERVICING AND
GENERAL REPAIR

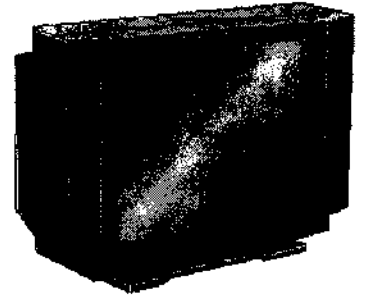

RENTALS, NEW
AND USED SALES

01296
682126

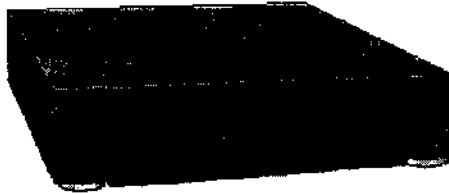

01296
682126

WHERE'S DAVE?
I CAN'T FIND HIM
THIS MORNING

DUNNO—BUT HE
WAS PARTYING
HARD LAST
NIGHT

YEAH! HE WAS
RAVING
ALRIGHT

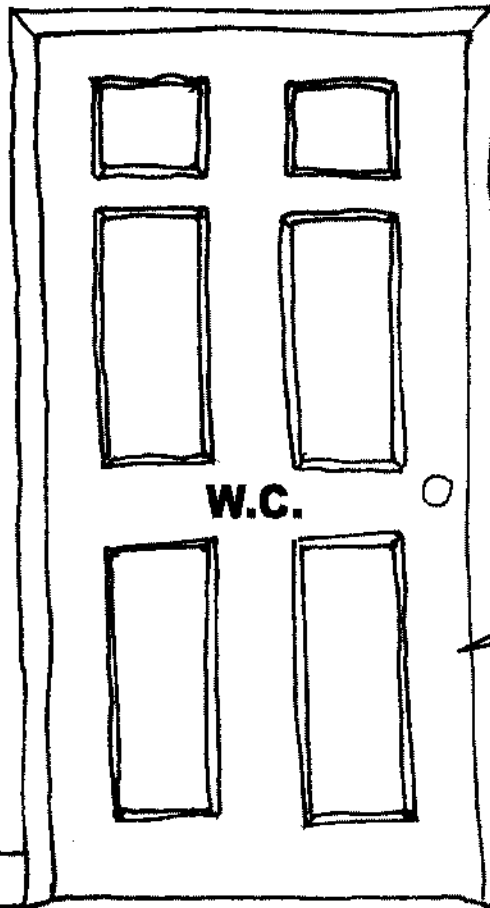

OH!
NEVER AGAIN!

Sergeant David's TV Parts Club

Fantabulous new psychedelic album available on Church Farm Records with 13 stunning new tracks -

- * Sergeant David's TV Parts Club Band
- * With a Little Help from My Beer
- * Transit In The Sky With Blue Smoke
- * Getting Fatter
- * Fixing A Set
- * She's Bleedin' Home
- * Being for the Benefit of Alison
- * Without Me, No TV
- * When I'm Fifty Four
- * Lovely Alison
- * What's Morning? What's Morning?
- * Sergeant David (*reprisal*)
- * A Dave In The Life

Sing-along-a-Dave

A DAVE IN THE LIFE

I fixed nine sets today oh boy
Some with no picture, some had no sound

And though the faults were rather small
Well I just fixed them all
With TV parts I found

I blew a fuse in my workshop
I didn't notice that the flames were there

A big Alpaca stood and stared
He'd seen it all before
Alison was not so sure
That the damage could be repaired

I took the sets back then oh boy
Four hundred miles in Transit Voyager
And though the bills were rather large
They had to pay each bit
Now I know how many sets it takes to fill an old Transit
I love to turn them on ...

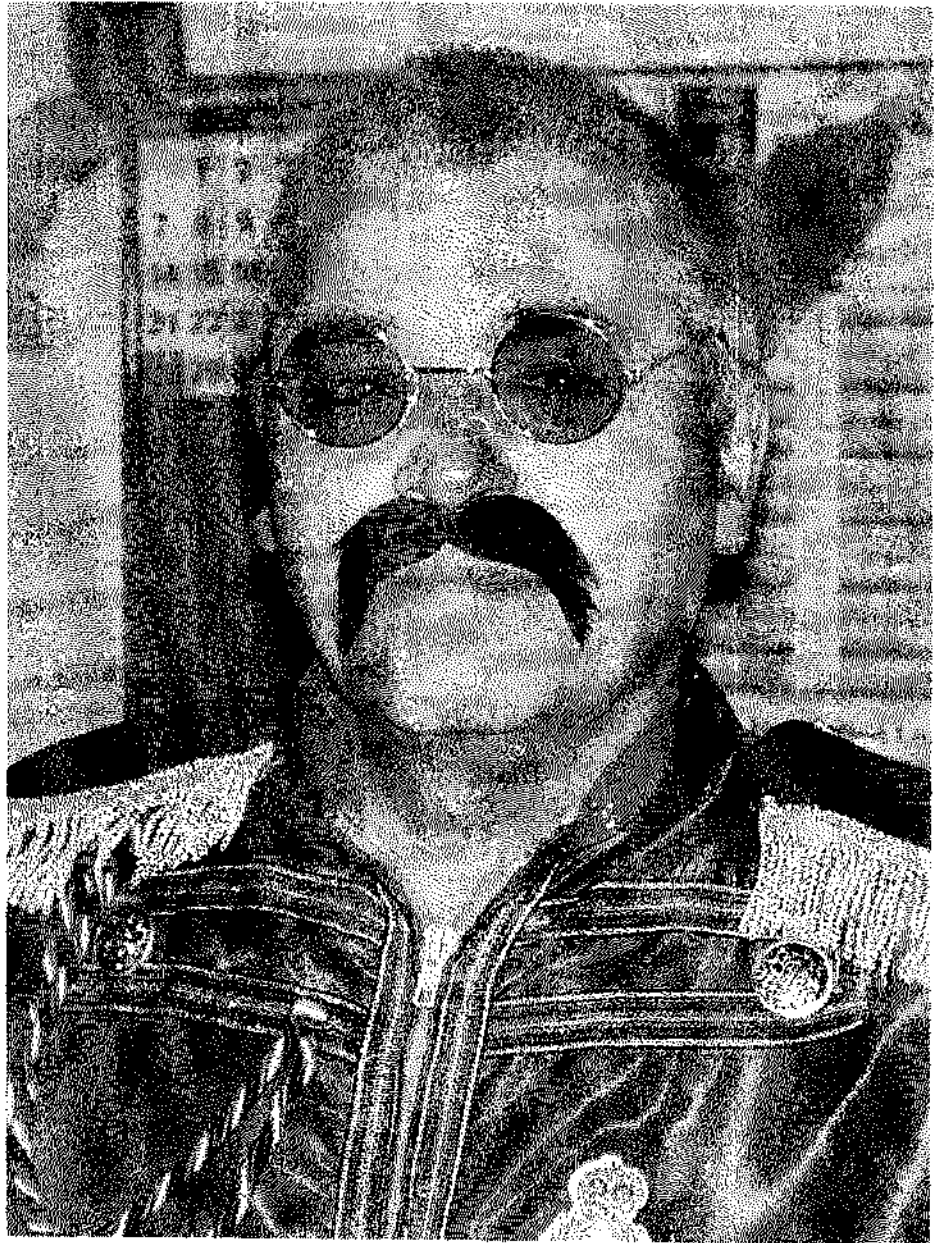

IMPORTANT NOTE

Several purchasers of this album have complained that when it finishes playing it just goes round and round endlessly repeating the same bit of gobbledegook. This is not a manufacturing defect. This is intentional, and is intended to allow you to reproduce Sergeant David's usual Friday night pub experience in the comfort of your own home.

STEREO HINT

To hear Sergeant David at his best you should play this album through two loudspeakers placed as far away from the listening position as possible.

TVs & Videos Fixed Tel: 01296 682126

STOP PRESS

Church Farm records have strenuously denied that Sergeant David used hallucogenic substances during the creation of this album. However, a source close to The Chronicle has revealed that Sergeant David did excessively partake in his own favourite choice of mind expanding substance - known locally as "larger and lime". It is not known if this has had any long term psychological effect. In fact, we are not too sure how anyone could tell...

Sgt David is now available as vinyl, VHS, and seedy

FLACKWELL ELECTRONICS

OF CHURCH FARM, ASTON ABBOTTS

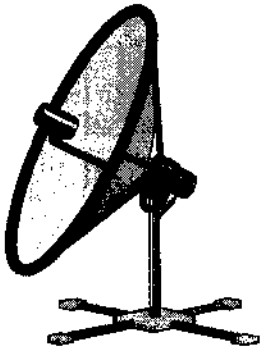

T.V. VIDEO AND
SATELLITE
SERVICING AND
GENERAL REPAIR

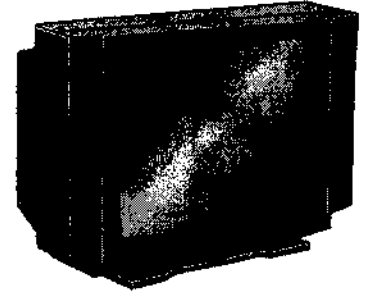

RENTALS, NEW
AND USED SALES

MOST MAKES
REPAIRED
THE SAME
DAY



NO CALL OUT
FEE WITHIN
ASTON
ABBOTTS

PHONE DAVE LEWIS
ON 01296 682126

ALISON'S SHOE MART

New Fashions direct from New York

Biggest Stock Of Shoes Outside of the Big Apple

- also available -

A Unique range of mens stripey shirts

Unbelievable new designs

Free sunglasses with every shirt

(No refunds)

Stop Press

James Perkins is one of Dave Lewis' greatest fans and he assisted Dave's journey home last Saturday night, despite Alison bending his ear.

Classified

ROOM TO LET. Recently vacated. Apply D. Lewis.

FLACKWELL ELECTRONICS

OF CHURCH FARM, ASTON ABBOTTS

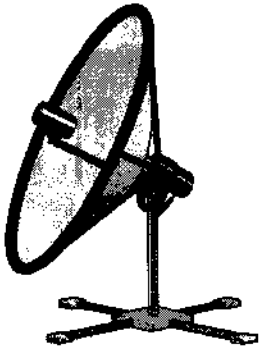

**T.V. VIDEO AND
SATELLITE
SERVICING AND
GENERAL REPAIR**

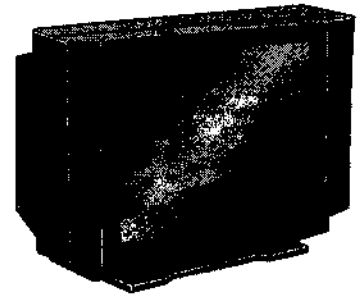

**RENTALS, NEW
AND USED SALES**

**MOST MAKES
REPAIRED
THE SAME
DAY**



**NO CALL OUT
FEE WITHIN
ASTON
ABBOTTS**

**PHONE DAVE LEWIS
ON 01296 682126**

FREE COMPETITION

Somewhere special in Aston Abbotts our Dave has written the following words :

**DAVE
WOZ
HERE**

To win, all you have to do is guess where he wrote those words, then approach Dave and say in a loud, stern voice "The place where you wrote 'Dave Woz Here' is [place name] and I claim my prize" — then just see what you get!

Shirleys Patented Superiorometer

**How Superior Are You?
Are you a cut above the
rest?**

**Do you know where you
stand in the pecking
order?**

**Use Shirleys amazing
new patented
Superiorometer to prove
just how far ahead of
the pack you are.**

**Just insert the
measuring tip into a
suitable orifice and
instantly find out how
many shells you rate!**

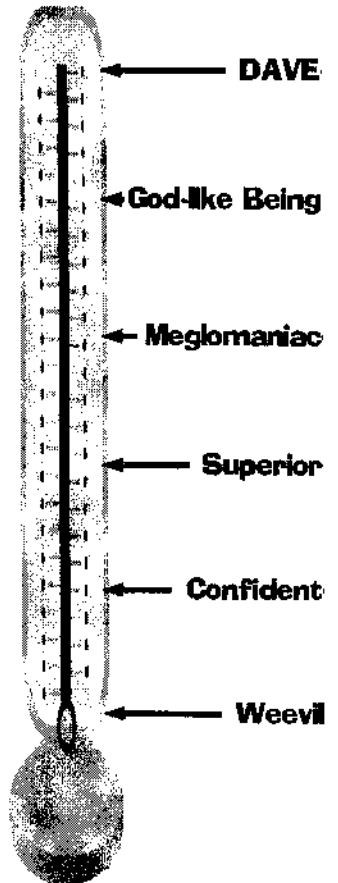

FLACKWELL ELECTRONICS

OF CHURCH FARM, ASTON ABBOTTS

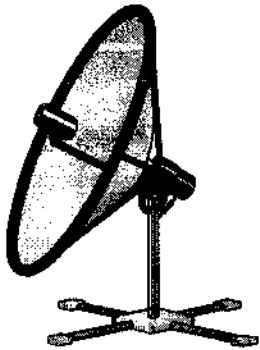

T.V. VIDEO AND
SATELLITE
SERVICING AND
GENERAL REPAIR

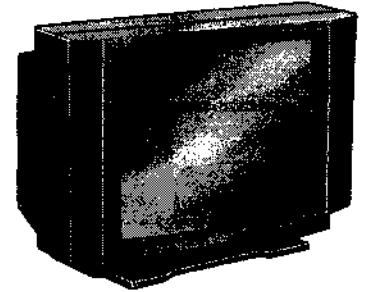

RENTALS, NEW
AND USED SALES

MOST MAKES
REPAIRED
THE SAME
DAY

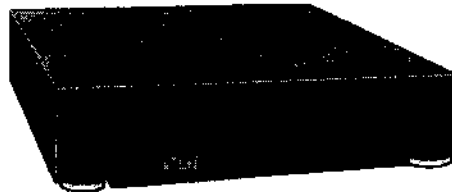

NO CALL OUT
FEE WITHIN
ASTON
ABBOTTS

PHONE DAVE LEWIS
ON 01296 682126

David's Driving School

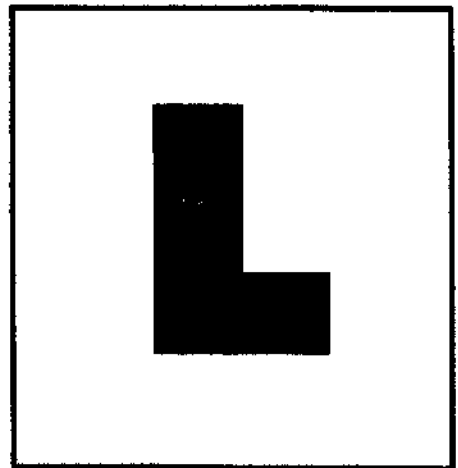

Surprise your family— learn to drive!
Try David's informal driving courses—Minimal paperwork.
Spin in a Sierra. Try a Transit. Rev up a RAV4.
Alpaca Avoidance course available.
With Dave anybody can learn to drive ~

Age Absolutely No Barrier!

WANTED

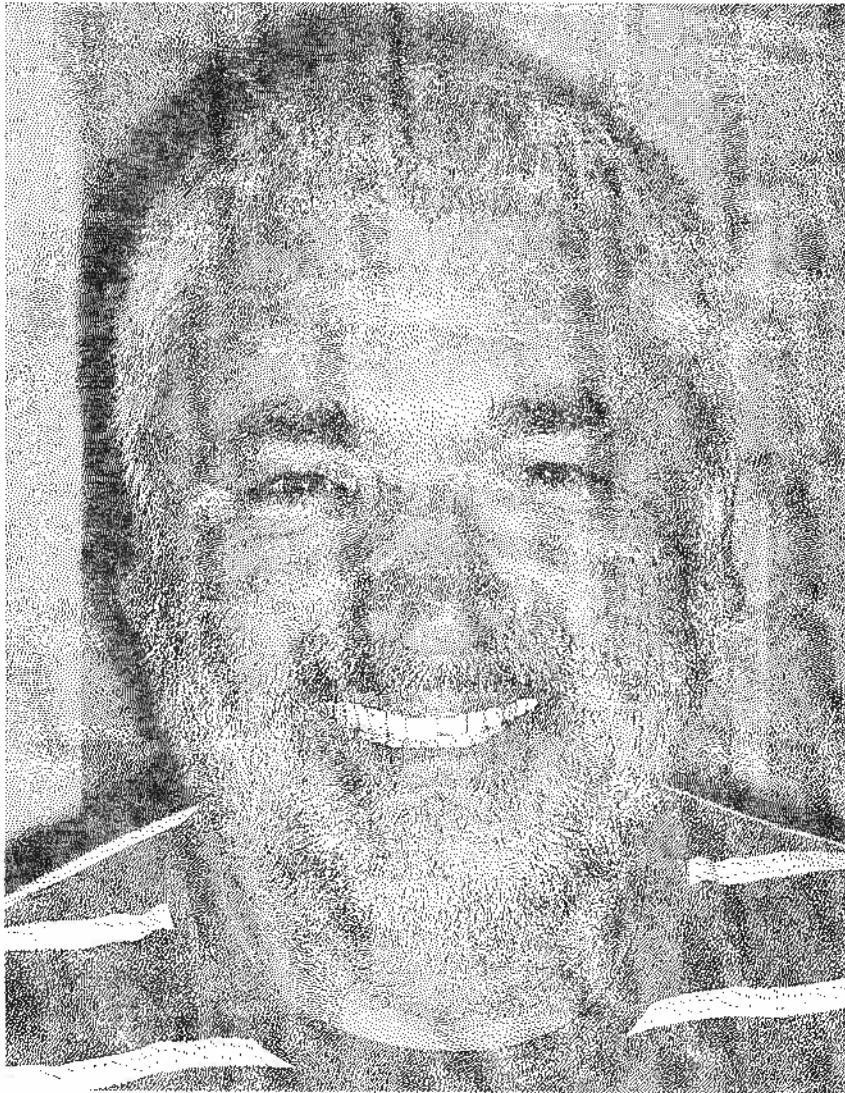

David W Lewis

For the hideous crimes of

★ Being in possession of seriously dodgy facial hair, *and...*

★ Assault with a deadly beard (charge pressed by Mrs A Lewis)

Do not approach this man - he may be bristly

Flackwell Electronics—TV and Video Repairs—01296 682126

FLACKWELL ELECTRONICS

OF CHURCH FARM, ASTON ABBOTTS

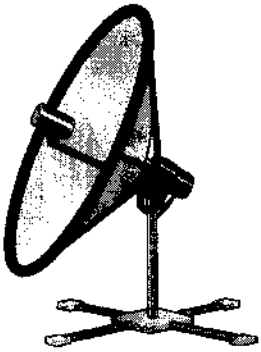

**T.V. VIDEO AND
SATELLITE
SERVICING AND
GENERAL REPAIR**

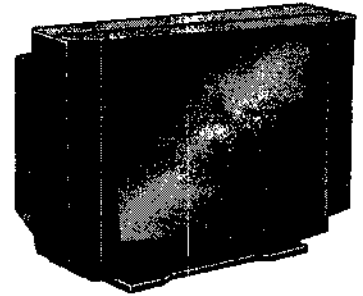

**RENTALS, NEW
AND USED SALES**

**MOST MAKES
REPAIRED
THE SAME
DAY**



**NO CALL OUT
FEE WITHIN
ASTON
ABBOTTS**

**PHONE DAVE LEWIS
ON 01296 682126**

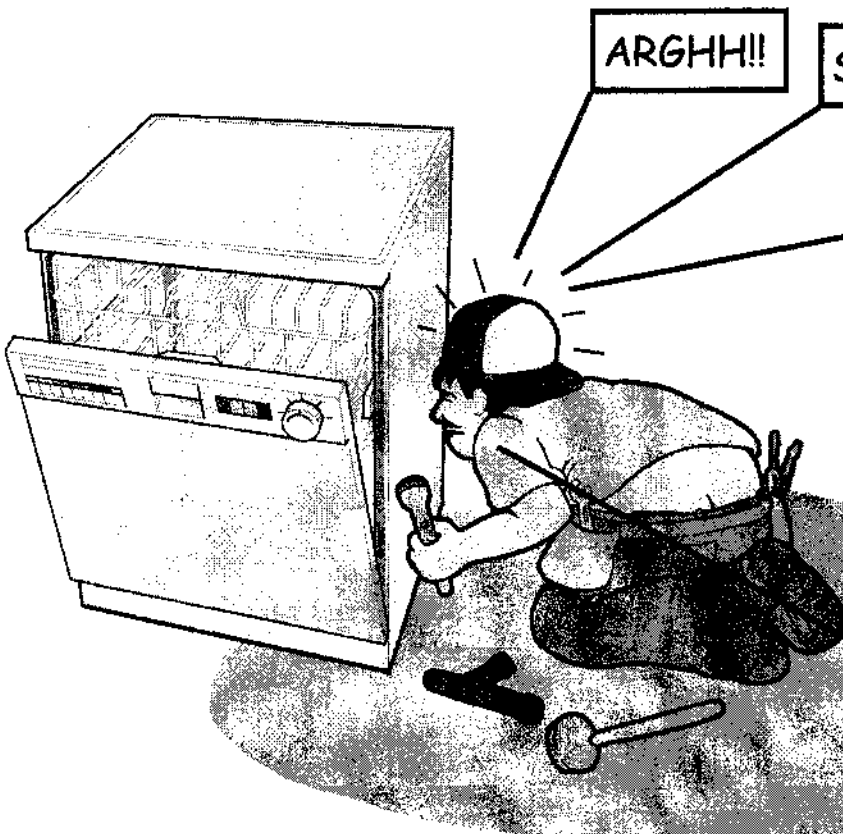

**SPECIALIST
DISHWASHER
SERVICE BY OUR
CARING SENSITIVE
TECHNICIAN**

OH B@!/?#{&\$!!!

FLACKWELL ELECTRONICS

OF CHURCH FARM, ASTON ABBOTTS

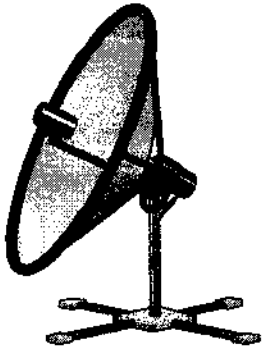

T.V. VIDEO AND
SATELLITE
SERVICING AND
GENERAL REPAIR

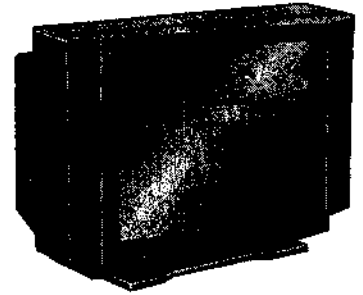

RENTALS, NEW
AND USED SALES

MOST MAKES
REPAIRED
THE SAME
DAY



NO CALL OUT
FEE WITHIN
ASTON
ABBOTTS

PHONE DAVE LEWIS
ON 01296 682126

STOP PRESS

Dave Lewis
launches
his new
Alpaca
suckling
service!



OUCH !!

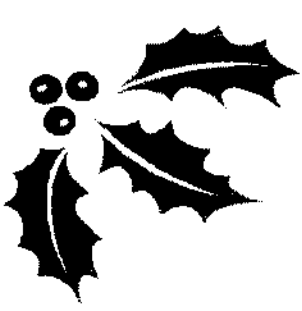

Merry Christmas
and a happy new year
from

Alison & Dave

Flackwell Electronics



FLACKWELL ELECTRONICS

OF CHURCH FARM, ASTON ABBOTTS

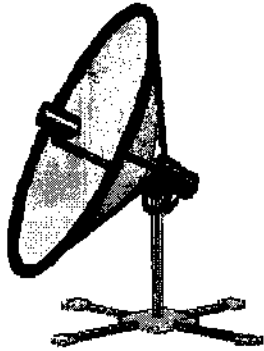

T.V. VIDEO AND
SATELLITE
SERVICING AND
GENERAL REPAIR

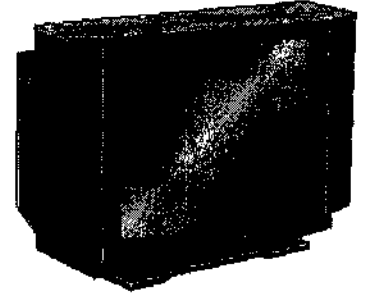

RENTALS, NEW
AND USED SALES

01296
682126



01296
682126

STOP PRESS: Dave Lewis Hunts A Mouse In His kitchen

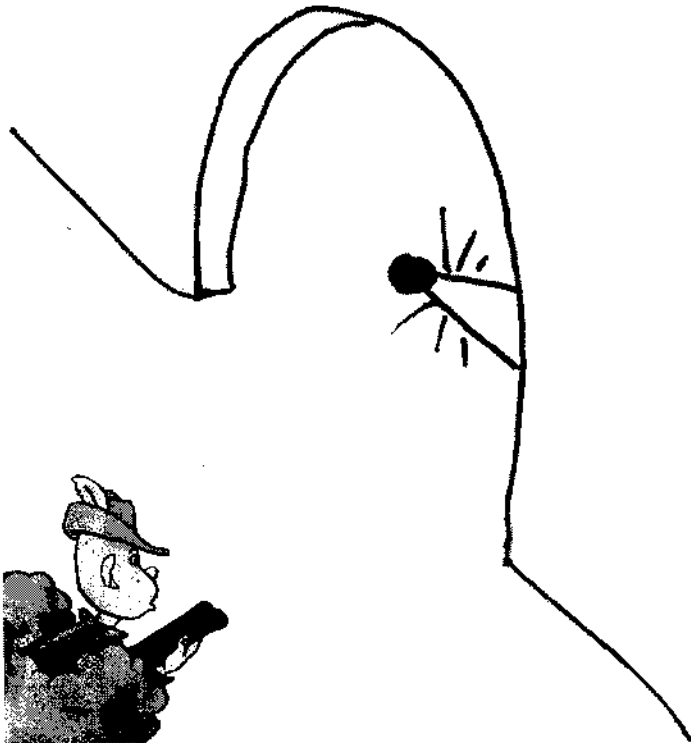

THE WAY DAVE TELLS IT

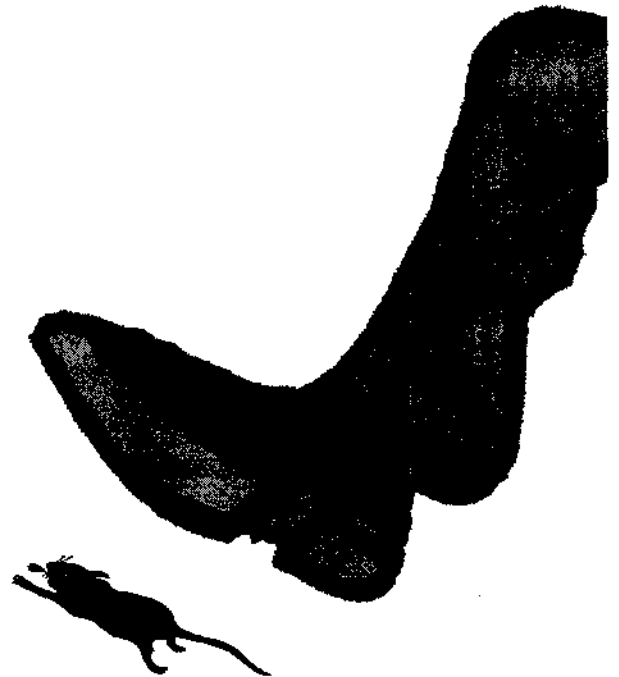

THE WAY THE MOUSE TELLS IT

FLACKWELL ELECTRONICS

OF CHURCH FARM, ASTON ABBOTTS

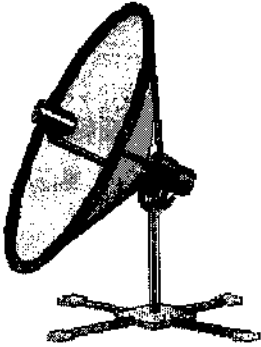

**T.V. VIDEO AND
SATELLITE
SERVICING AND
GENERAL REPAIR**

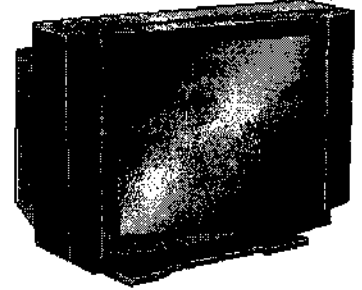

**RENTALS, NEW
AND USED SALES**

**01296
682126**



**01296
682126**

My Darling Valentine

Where do I find the words to express what I feel in my heart for you?

Through these many years that we have been together you have been my faithful companion - my friend. Each morning when I wake up you are there, waiting for me, ready to go. You have responded to my merest touch. You have done everything I ever asked of you - especially when ridden hard. You have never complained, even when I have cursed you, kicked you, or lent you to my friends. I have spent much time underneath you recently, yet still you have taken my full load. I have never lost my love for you, even now, in the twilight of your life, when you have suffered a few screws loose, a noisy big end and a leaky sump. Even though another Ford Transit has now come into my life I won't forget our three hundred and forty two thousand miles together. You are my only voyager - you are my everything

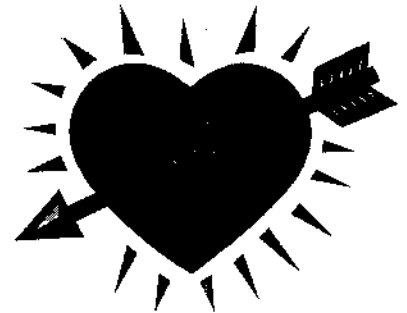

Your loving David x x x x x

FLACKWELL ELECTRONICS

OF CHURCH FARM, ASTON ABBOTTS

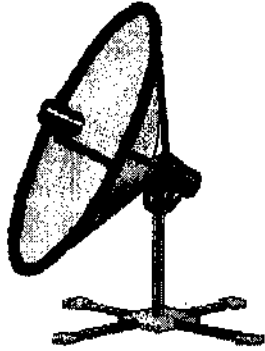

T.V. VIDEO AND
SATELLITE
SERVICING AND
GENERAL REPAIR

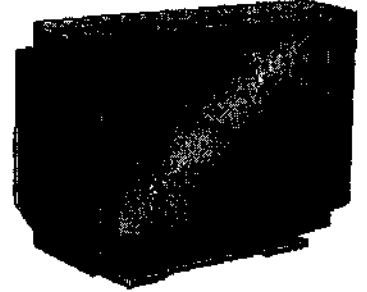

RENTALS, NEW
AND USED SALES

01296
682126



01296
682126

**"FOR
GOD'S
SAKE
WAKE UP
DAVID!
YOU'RE
SNORING
AGAIN!"**

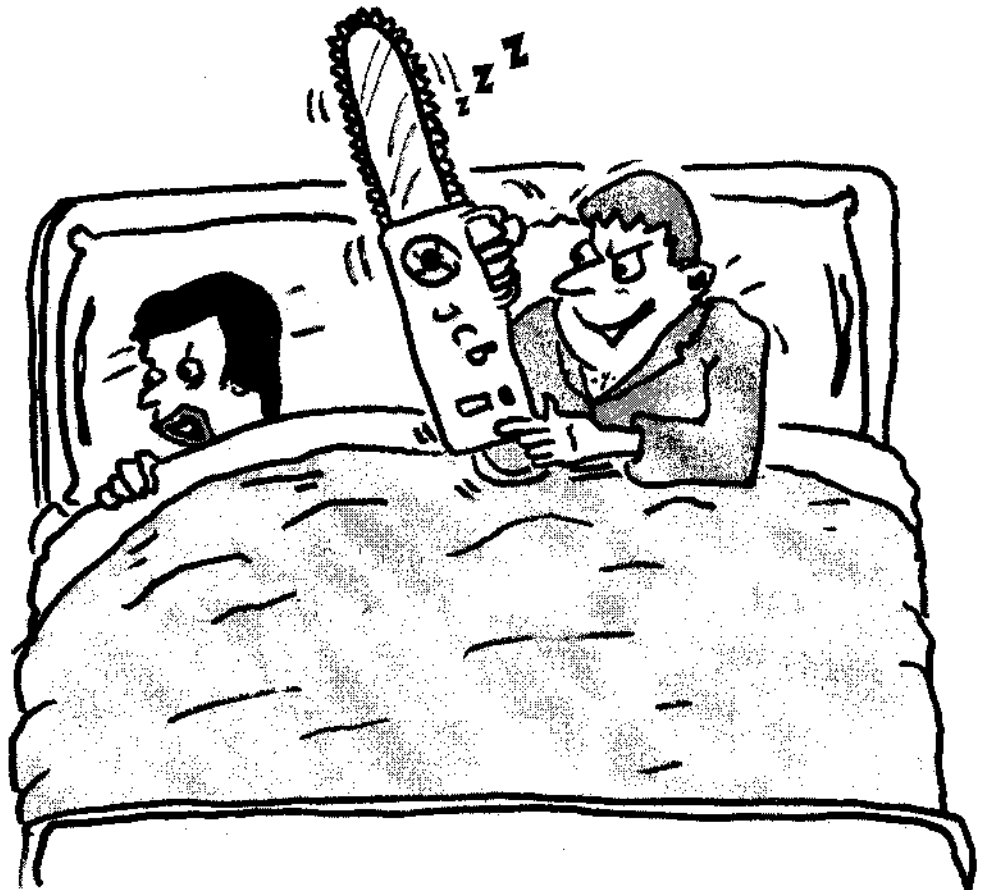

FLACKWELL ELECTRONICS

OF CHURCH FARM, ASTON ABBOTTS

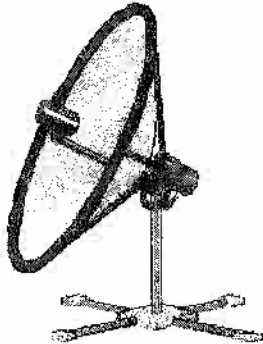

T.V. VIDEO AND
SATELLITE
SERVICING AND
GENERAL REPAIR

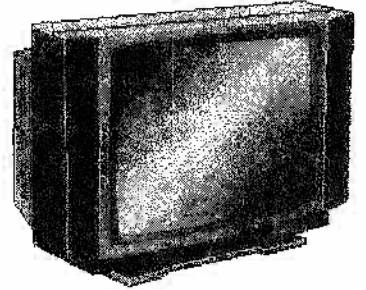

RENTALS, NEW
AND USED SALES

01296
682126

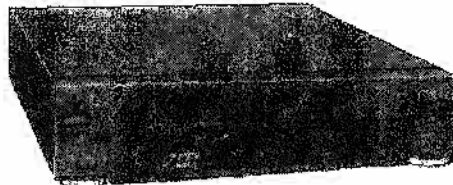

01296
682126

DAVE'S TYRE SERVICE

- * **Busy social life? We change tyres on the move—you don't even have to stop the car**
- * **Full range of double-retreads from G.Ippo Tyres Ltd**

* * * * *

**SPECIAL OFFERS FOR
H.M.CUSTOMS and EXCISE
EMPLOYEES :**

- * **Pay once—change the tyre twice**
- * **No VAT**



FLACKWELL ELECTRONICS

OF CHURCH FARM, ASTON ABBOTTS

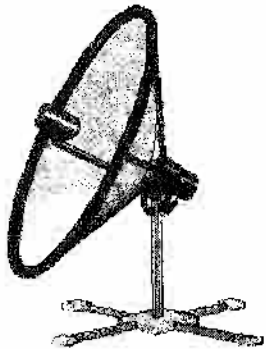

T.V. VIDEO AND
SATELLITE
SERVICING AND
GENERAL REPAIR

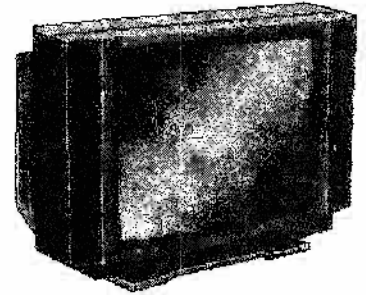

RENTALS, NEW
AND USED SALES

01296
682126

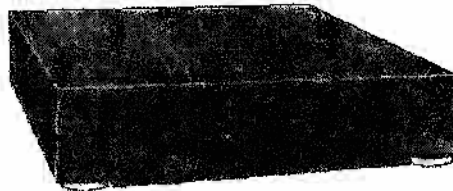

01296
682126

CAR PHOTO SERVICE

Would you like a professionally taken picture of your car??

Our highly experienced car model Mr David W Lewis will take your car and position it perfectly in front of strategically placed cameras located around the county. Less than two weeks later a bill for £60 will drop through your letter box.

Please note: Prints are extra - proof of driving license required. Non-optional points scheme applies. Personal collection option (additional costs apply). Many, many successful pictures taken.

Let David know if you wish him to take on a particular pose inside the car - the standard option is him peering through the windscreen wearing a startled expression and with his mouth starting to form the letter "F...".

FLACKWELL ELECTRONICS

OF CHURCH FARM, ASTON ABBOTTS

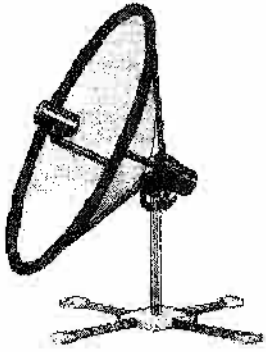

T.V. VIDEO AND
SATELLITE
SERVICING AND
GENERAL REPAIR

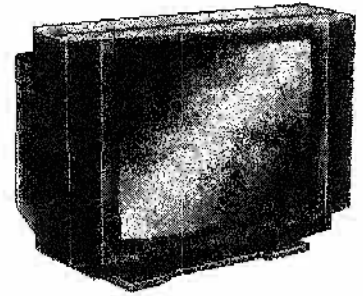

RENTALS, NEW
AND USED SALES

01296
682126

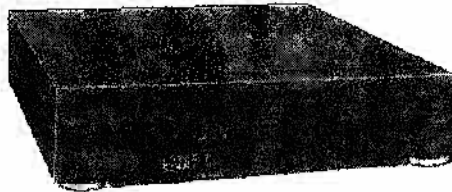

01296
682126

DAVE LEWIS' EYE TEST

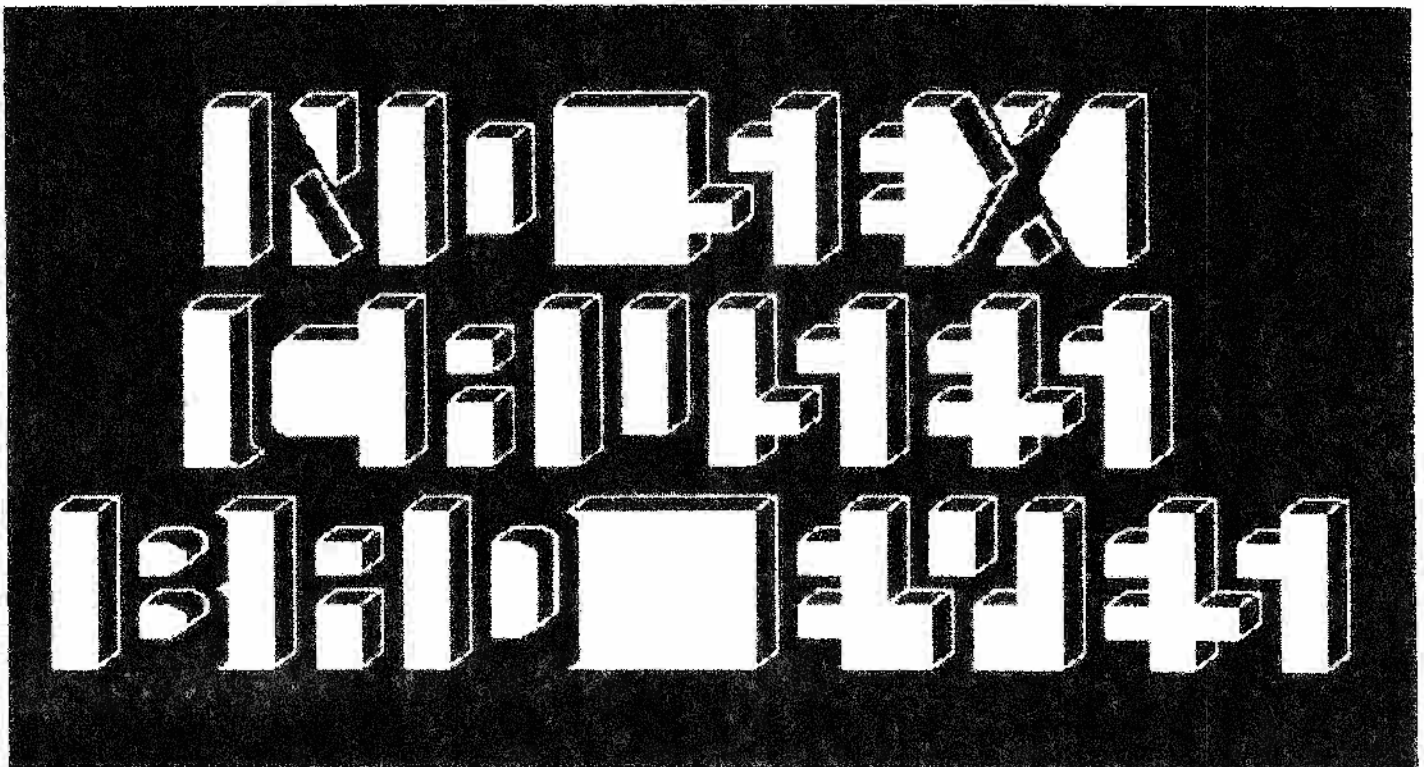

INCREASE DISTANCE FROM CHART UNTIL IT IS READABLE

FLACKWELL ELECTRONICS

OF CHURCH FARM, ASTON ABBOTTS

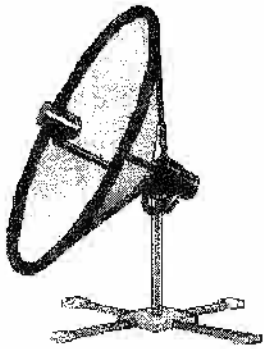

T.V. VIDEO AND
SATELLITE
SERVICING AND
GENERAL REPAIR

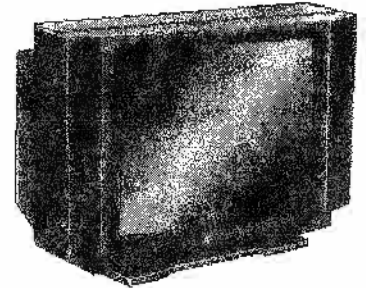

RENTALS, NEW
AND USED SALES

01296
682126

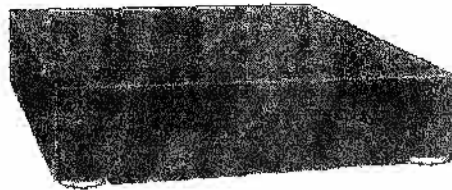

01296
682126

Flackwell Electronics are proud to announce the opening of Aston Abbots first ride-through TV sales and service showroom.

Just trot up on your horse and select your TV. Personal service and a guaranteed leg ~~up~~ up afterwards.



A Very Special Offer for all of our customers:

GET INTO HOT WATER WITH DAVE

With every TV purchased you get a free entry into our draw for The Dave Lewis Complete Hot-Tub Experience. Join Dave and his chum Dirty Harry for a memorable evenings entertainment and be the talk of the village. A very special ~~naturist~~ natural experience.

FLACKWELL ELECTRONICS

OF CHURCH FARM, ASTON ABBOTTS

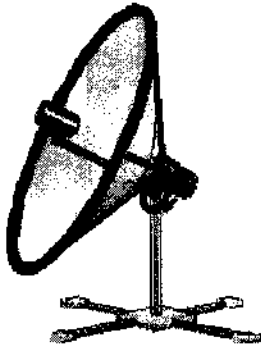

T.V. VIDEO AND
SATELLITE
SERVICING AND
GENERAL REPAIR

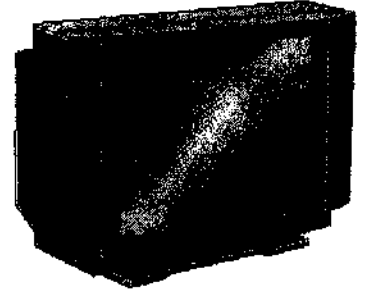

RENTALS, NEW
AND USED SALES

01296
682126



01296
682126

Church Farm News

Whodunit ?

A dastardly deed was done at the Whyte's 25th wedding anniversary bash and our poor hero Dave was the victim. There was Dave, in the early hours of the morning, leaning over the swimming pool, innocently filling his mega-waterpistol, when some evil person crept up behind and shoved him in. The enormous splash that resulted was heard clearly all over Aston Abbots, but by the time a soggy, bedraggled Dave had spluttered his way out of the water there was nobody close by and everybody was pretending that they hadn't seen a thing. So whodunit? I notice that a certain ex-submariner smirks broadly every time the story is retold – could he possibly know anything about it?

Alison Takes The Plunge

Following last month's back page article about the Dave Lewis hot-tub experience we can now report that Mrs Alison Lewis is no longer a hot-tub virgin. At present we don't know if she followed husband Dave's lead with an *au naturelle* adventure.... but we hope to find out when Tracy gets the film back from Boots.

Medical Study

We understand that the sound of snoring from Church Farm has become so bad that our intrepid electronics engineer Dave Lewis has now become part of a medical study. Dave has been so overwhelmed by this attention that he has offered to bequeath his body to science. So far the Natural History Museum have failed to take up the offer.

FLACKWELL ELECTRONICS

OF CHURCH FARM, ASTON ABBOTTS

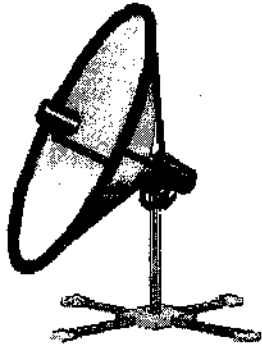

**T.V. VIDEO AND
SATELLITE
SERVICING AND
GENERAL REPAIR**

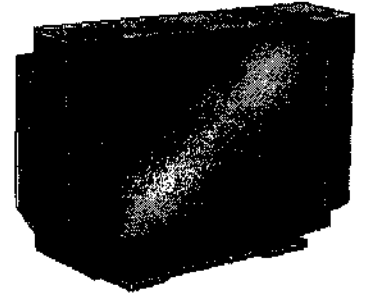

**RENTALS, NEW
AND USED SALES**

**01296
682126**



**01296
682126**

**DAVE IS
FORCED TO
TURN OFF
HIS
IN-CAR
NAVIGATION
SYSTEM**

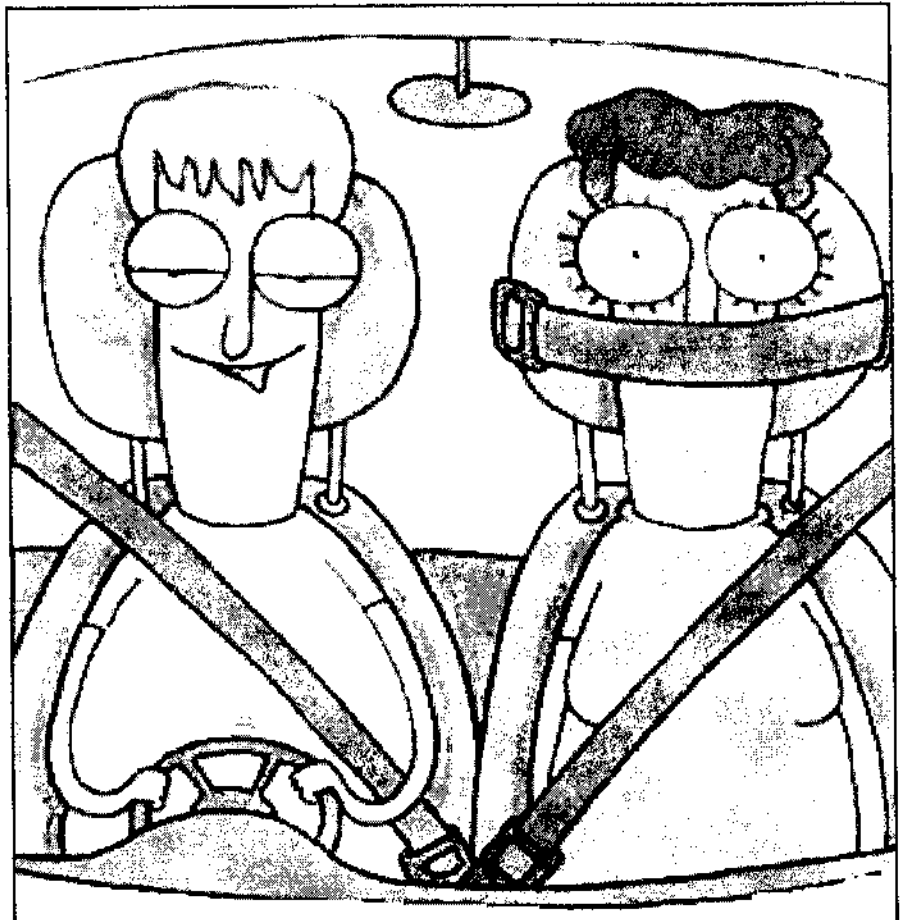

FLACKWELL ELECTRONICS

OF CHURCH FARM, ASTON ABBOTTS

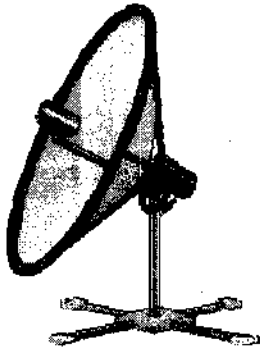

T.V. VIDEO AND
SATELLITE
SERVICING AND
GENERAL REPAIR

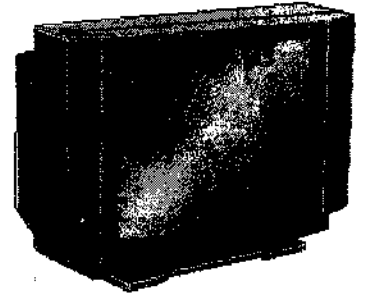

RENTALS, NEW
AND USED SALES

01296
682126



01296
682126

Dear you KNOW Who
I am holding your
yellow tie hostage.
It is safe if you do
as I say and do NOT
contact the police.
If you dont pay your
outstanding TV aerial
repair bill
immediately - the tie
gets it.

FLACKWELL ELECTRONICS

OF CHURCH FARM, ASTON ABBOTTS

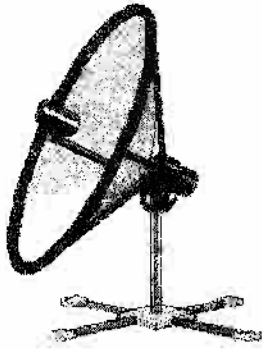

T.V. VIDEO AND
SATELLITE
SERVICING AND
GENERAL REPAIR

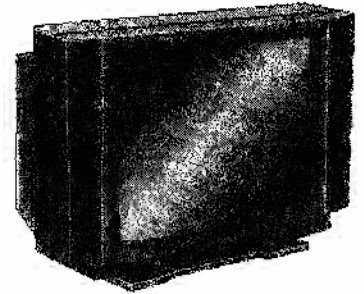

RENTALS, NEW
AND USED SALES

01296
682126



01296
682126

The End Of The Back Page

For my five years as editor of The Chronicle I have, each month, stolen half of the back page – a full-page advert purchased at a premium rate by Flackwell Electronics – to heap insults and derogatory remarks upon the proprietor of that company, Mr David Lewis. When I have failed to find a suitable insult I have turned my sights upon his lovely wife, our gossip columnist Alison.

Now, as I retire as editor, I believe the time has come to allow these poor people a little peace in their lives. No longer will they await The Chronicle's delivery with apprehension, no longer will they live in fear of finding intimate details of their private lives exposed to the whole of Aston Abbotts. As I finish this paragraph I will draw a line under this episode and undertake that in future I will only write serious items for the back page, and in future I will accord Dave Lewis all of the respect that he deserves. It ends here. ~ Phil Spooner.



An Extra Second Of Life

Aston Abbotts is buzzing with the news that we have a leap-second on New Years Eve. For one second at midnight on December 31st the clocks will indicate 23:59:60 as we all gain an extra second in our lives. There is a furious speculation as to what villagers are going to do with this extra second, but Dave Lewis is adamant as to how his one second will be spent. Dave is going to ~~be~~ ~~of~~ of course. Twice.

Editor's note: We apologise for the Chronicle Censor's final intervention—but she is also retiring this month.

FLACKWELL ELECTRONICS

OF CHURCH FARM, ASTON ABBOTTS

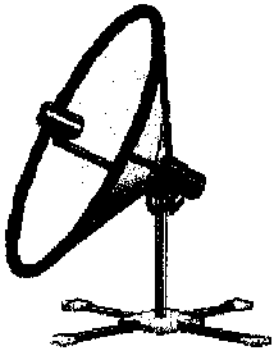

**T.V. VIDEO AND
SATELLITE
SERVICING AND
GENERAL REPAIR**

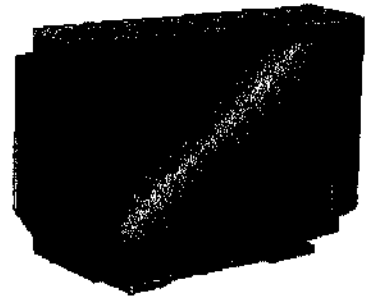

**RENTALS, NEW
AND USED SALES**

**01296
682126**



**01296
682126**

Where is Dirty Harry?

Reward Offered for information on the whereabouts of

Mr Dirty Harry

last seen in a fine stand-up performance on stage at the Aston Abbotts Christmas Show. After John Whyte got him to wave at the audience, his whereabouts have become a mystery. One lady had a firm grip on him for a while, and a beaming Gnome is rumoured to have sat on him. Has he been kidnapped in retaliation for the yellow tie ransom demand? It's not like Dirty Harry to limp around getting lost - after all, he's a hard man with a good head on him. We believe that at least one audience member tried to woo him away, but just got shafted.

Anybody with information on the whereabouts of Dirty Harry should contact Alison, who is desperately worried about her special friend and wants him back.



FLACKWELL ELECTRONICS

OF CHURCH FARM, ASTON ABBOTTS

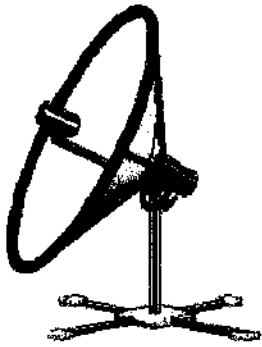

T.V. VIDEO AND
SATELLITE
SERVICING AND
GENERAL REPAIR

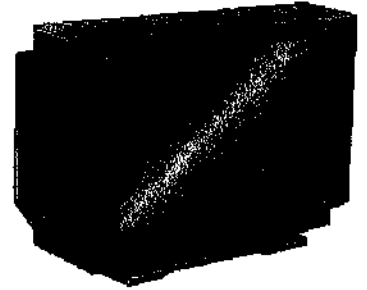

RENTALS, NEW
AND USED SALES

01296
682126



01296
682126

**DAVE AND ALISON GO TO MILTON KEYNES SNOWDOME
TO PRACTICE FOR THEIR FIRST SKIING HOLIDAY**



FLACKWELL ELECTRONICS

OF CHURCH FARM, ASTON ABBOTTS

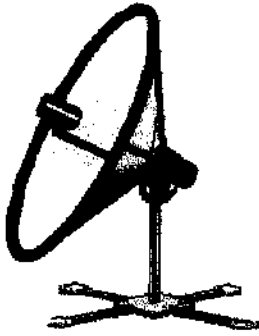

T.V. VIDEO AND
SATELLITE
SERVICING AND
GENERAL REPAIR

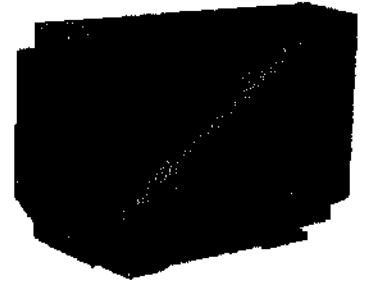

RENTALS, NEW
AND USED SALES

01296
682126



01296
682126

ALISON TRIES TO HOOVER UP ASHES FROM THE FIREPLACE

DAVID—I THINK
I'VE HAD A SMALL
FIRE IN THE
VACUUM CLEANER

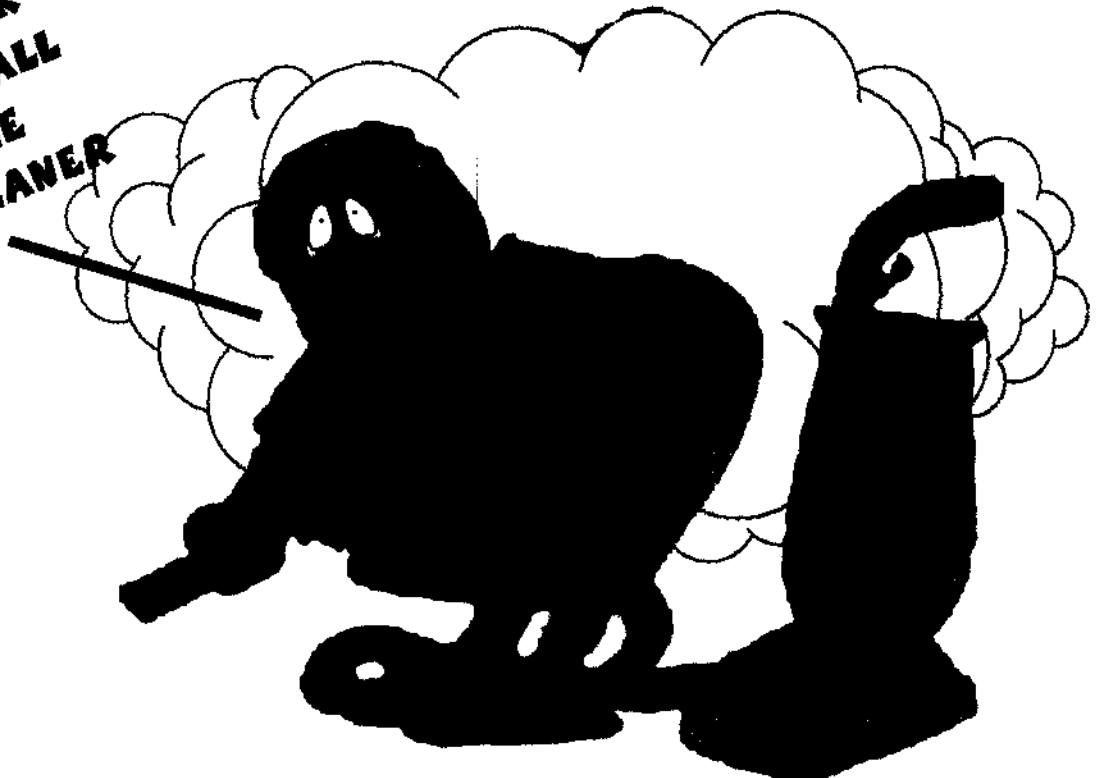

FLACKWELL ELECTRONICS

OF CHURCH FARM, ASTON ABBOTTS

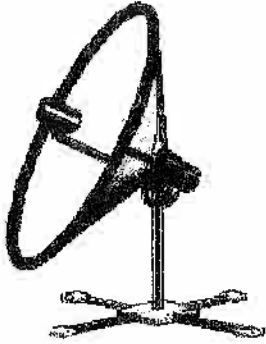

T.V. VIDEO AND
SATELLITE
SERVICING AND
GENERAL REPAIR

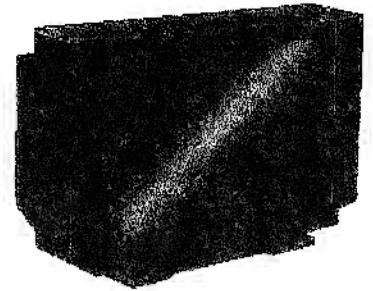

RENTALS, NEW
AND USED SALES

01296
682126



01296
682126

AN APOLOGY

I the undersigned wish to apologise for my behaviour on the night of Saturday 4th March. Those who know me will understand that what happened was completely out of character and so I humbly offer this heartfelt apology.

David Octopus Lewis

Legal Disclaimer

The above apology is intended for, but not limited to, Mr T Reese, Mrs S Reese, the village of Stewkley, Mr J Whyte, Mrs D Whyte, the regulars at The Carpenters Arms, the writers and fans and previous performers of the songs "Unchained Melody" and "Is This The Way To Amarillo", the lady in the red jacket standing by the bar who left suddenly (I hope the dog is better now), Mrs D Whyte, ABC Taxis Limited, and the lady who lives on the corner of The Green who is wondering what has suddenly killed off the miniature conifer in the planter by her front door.

No liabilities accepted.

Flackwell Electronics — Purveyors of Plasma Screens to the Gentry

FLACKWELL ELECTRONICS

OF CHURCH FARM, ASTON ABBOTTS

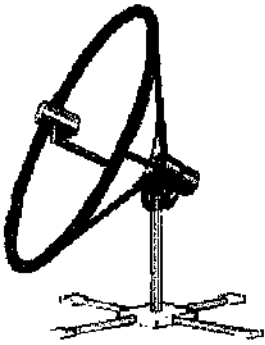

T.V. VIDEO AND
SATELLITE
SERVICING AND
GENERAL REPAIR

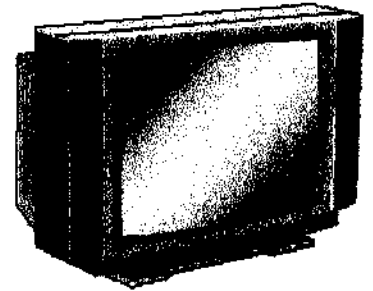

RENTALS, NEW
AND USED SALES

01296
682126



01296
682126

DAVES'S DIVINING SERVICE

WATER SHORTAGE? NO PROBLEM!!!!

Beat the hosepipe ban! It is a little known fact that many household internal walls contain central heating and other pipes within which flows an apparently limitless supply of water. Our premier operative Mr D. Lewis and his special divining tool is especially trained to sniff out water in the most unlikely of walls.

SPECTACULAR RESULTS GUARANTEED - EVERY TIME!
VISIT OUR NEWLY REDECORATED SHOW HOME

Important Notes

Due to the nature of Mr Lewis's operations the room may be uninhabitable for up to 28 days after his visit. Redecoration will be essential, and is carried out free of charge. Some customers have complained of a loud squelchy noise when walking on their carpets after Mr Lewis has completed his operations - this is quite normal and the noise will fade naturally over a period of three to eighteen months.

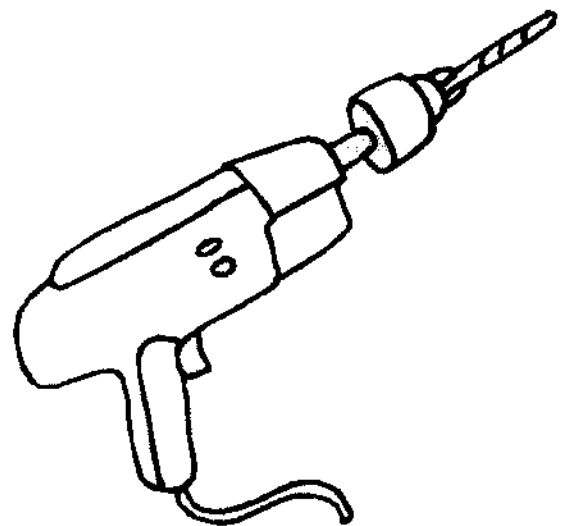

*Mr Lewis' special divining tool,
seen here ready for action*

Flackwell Electronics — Purveyors of Plasma Screens to the Gentry

FLACKWELL ELECTRONICS

OF CHURCH FARM, ASTON ABBOTTS

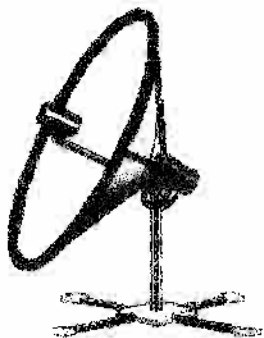

T.V. VIDEO AND
SATELLITE
SERVICING AND
GENERAL REPAIR

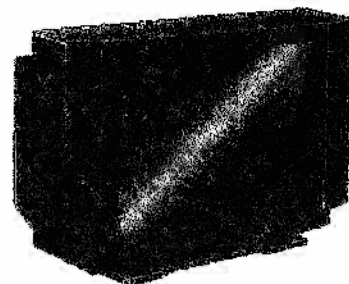

RENTALS, NEW
AND USED SALES

01296
682126



01296
682126

DON'T KNOW WHERE YOU'RE GOING? NEED CAR NAVIGATION HELP? YOU NEED AN...

**AWFULLY
LOUD
INSISTENTLY
SUPERIOR
ORAL
NAVIGATOR**

Unlike old-fashioned car navigation devices the A.L.I.S.O.N. device will not irritate you with unnecessary directions. No, the A.L.I.S.O.N. waits until after you have made a mistake and *then* corrects you with its superior announcement technology.

The library of useful announcements built in to A.L.I.S.O.N. includes helpful oral prompts such as *'David, you should have taken that last turning'*, *'Why are you going this way?'*, and *'I suppose you think this is quicker'*.

A.L.I.S.O.N. comes with very little user control---in fact you have no control over it at all. Two-volume settings are provided: *Loud* and *Shutupyousillycow*. Built in argumentation technology allows for user feedback, although it should be noted that this is usually ineffectual and frequently counter-productive.

Purchasers are warned that A.L.I.S.O.N. has no on-off switch and may go off at any time. However, the device has been known to mute automatically when placed on the rear seat of light aircraft flying through thick cloud at low altitudes over the English Channel. This silence is only temporary.

Flackwell Electronics — Purveyors of Plasma Screens to the Gentry

FLACKWELL ELECTRONICS

OF CHURCH FARM, ASTON ABBOTTS

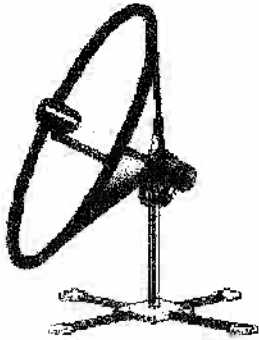

T.V. VIDEO AND
SATELLITE
SERVICING AND
GENERAL REPAIR

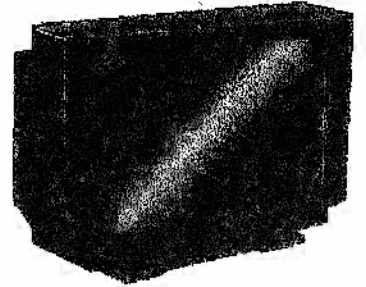

RENTALS, NEW
AND USED SALES

01296
682126



01296
682126

REWARD

Lost in the region of Bricstoc—a priceless family heirloom

Mr David Lewis of Flackwell Electronics has lost an extremely valuable antique timekeeping device. Last seen in the vicinity of Bricstoc, this rare piece is instantly recognisable. Unlike modern timepieces and chronographs which use the modern, intuitive, easily understood system of hands pointing at numbers, this artefact uses a system of decimal numerals which only those especially trained in its operation can understand.

Mr Lewis is understandably *extremely* upset by the loss of this prized family heirloom, which he had been hoping to pass on to his grandchildren. Therefore he is prepared to give a reward of up to 20% of the value of this chronographic masterpiece for its safe return. (The value of the piece is to be judged by local experts Mr John Whyte and Mrs Deidre Whyte.)

The timepiece in question is extremely rare and it should be handled carefully. The piece will be easily recognised as Mr Lewis insists that it is the only one personally indented by master craftsman Mr Casio, who created it. Most unusually (for those used to modern chronographs) its case and strap are hand-fashioned from some kind of black plasticky material and its time display area is protected with some unknown substance which, whilst once almost as clear as glass, is now almost obscured with scratches and small indentations.

There is no truth in the rumour that Mr Lewis' grandchildren are to offer an even larger reward for the NON-return of this item.

Flackwell Electronics — Purveyors of Plasma Screens to the Gentry

FLACKWELL ELECTRONICS OF CHURCH FARM, ASTON ABBOTTS

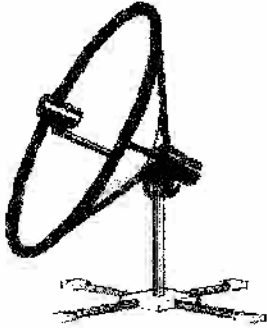

T.V. VIDEO AND
SATELLITE
SERVICING AND
GENERAL REPAIR

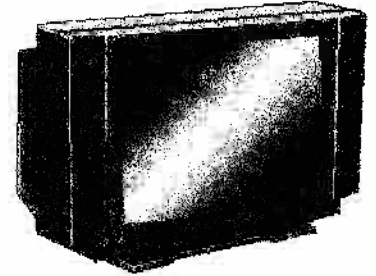

RENTALS, NEW
AND USED SALES

01296
682126



01296
682126

HERO DAVE SAVES 'GOD'

This story begins and ends with a miracle.

The first miracle happened on the morning after Astonbury when musical director Neil went back to the scene of his triumph and was humbled by the words 'NEIL IS GOD' emblazoned across the stage in 'fiery letters of gold'.

Neil, being a modest and unassuming chap, made scant reference to his newly

bestowed deity in the days that followed. Therefore it came as a bit of a surprise that whilst on a short holiday in Portugal, intoxicated by nothing more than his own glory and the adulation of his followers, he decided to demonstrate his new found divinity by walking on water.

We of the Astonbury organising committee and the fans of the Christmas

cabaret would like to extend our heartfelt thanks to Dave Lewis for extracting Neil from the swimming pool so quickly. If it had not been for Dave's miraculous rescue, Aston Abbotts would have been deprived of the guru behind some of the best entertainment events ever staged in any little village... anywhere. Tragedy was averted. Well done Dave - we salute you.

Flackwell Electronics - Purveyors of plasma screens to anybody who thinks they have a right to one - just help yourself - don't worry about it - you're misunderstood - you must have had a deprived childhood - it's not your fault - YOU are the victim - it's no problem - you can all have one - just pop round, bang on the window, and ask for 'de Judge'.

FLACKWELL ELECTRONICS

OF CHURCH FARM, ASTON ABBOTTS

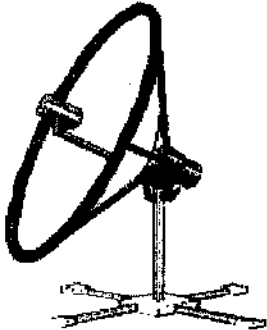

**T.V. VIDEO AND
SATELLITE
SERVICING AND
GENERAL REPAIR**

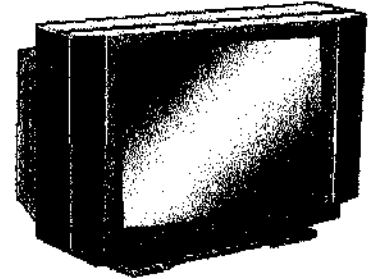

**RENTALS, NEW
AND USED SALES**

**01296
682126**

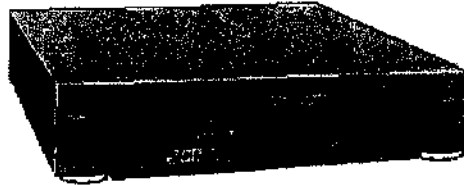

**01296
682126**

VOTE FOR DAVE

... AND CHOP 'EM OFF!

Mr David W Lewis is pleased to announce his candidacy for the next general election. Mr Lewis will be standing on a law and order ticket.

Are you as dismayed as Mr Lewis by the breakdown of the rule of law in modern society? How many times have you been appalled by the lenient sentences handed down by our judges? Well, Mr Lewis has one simple solution to these problems —chop 'em off!

Under Mr Lewis' regime

punishments will be chosen for their deterrent value—and they will fit the crime. No longer will namby-pamby weak-willed politicians and sympathetic do-gooders be allowed to let these b*****ds get away with it. Mr Lewis and his enforcer Magistrate Magners will see that real retribution is meted out.

Problems with thieves breaking in your houses and stealing your prized possessions? Solution: castration. Sleazy

slimeballs conning their way into old peoples houses and robbing them? Solution: double castration. Sex attackers, rapists and kiddie-fiddlers? Solution: triple castration.

Don't put up with the c**p any more. Next election pick up a rusty hacksaw blade and join the Surgical Dave Lewis Party. Let's show these low-lifes a thing or two. Let's chop 'em off!!!!

Flackwell Electronics - Purveyors of plasma screens to the Gentry

FLACKWELL ELECTRONICS

OF CHURCH FARM, ASTON ABBOTTS

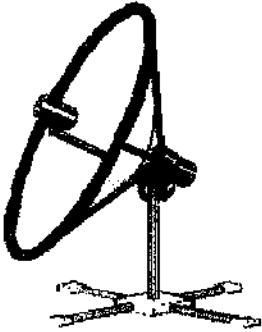

T.V. VIDEO AND
SATELLITE
SERVICING AND
GENERAL REPAIR

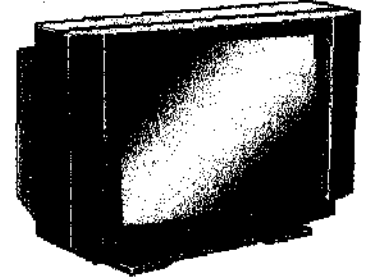

NEW AND USED SALES
LCD, PLASMA, DVD

01296
682126



01296
682126

DAVE'S VEILED SECRET

**Dave finds a
sure-fire way
to hide from
Alison—but
would you let
this man into
your home to
fix your TV set?**

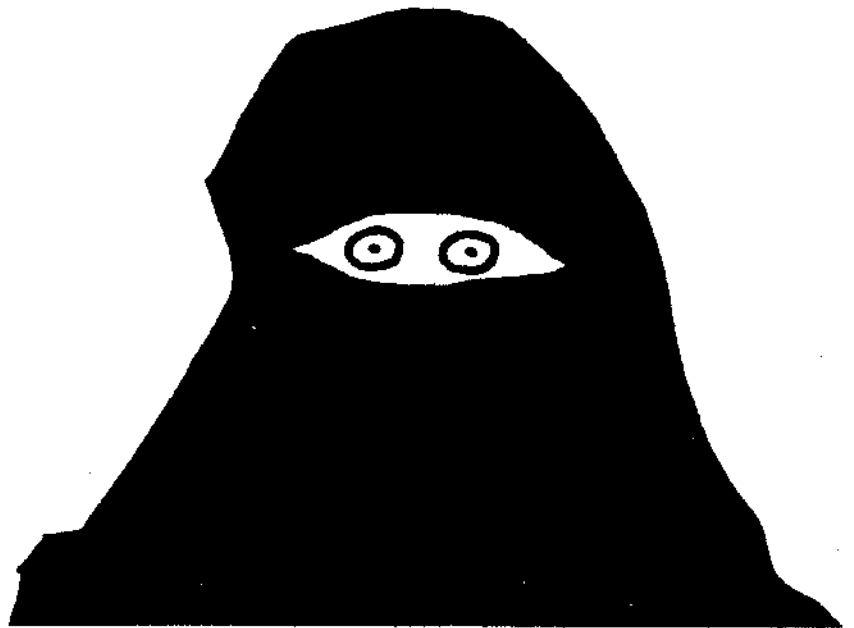

Flackwell Electronics - Purveyors of plasma screens to the gentry

FLACKWELL ELECTRONICS

01296 652120

ALISON AND DAVE

WISH ALL OF THEIR FRIENDS IN ASTON ABBOTTS

A MERRY CHRISTMAS

AND

A HAPPY NEW YEAR

Dave and Alison Host a Pre-Xmas Wine Tasting...

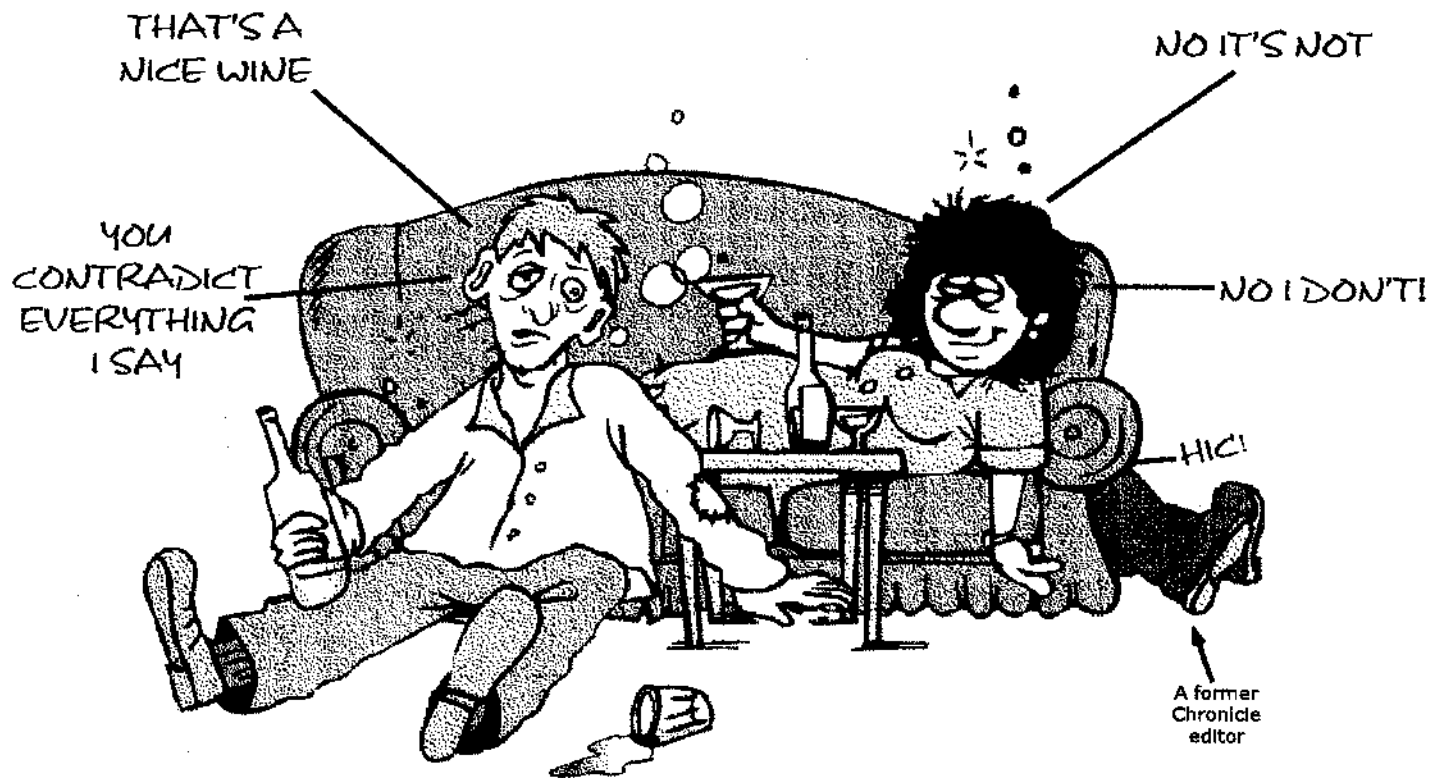

Flackwell Electronics - Purveyors of plasma screens to the gentry

FLACKWELL ELECTRONICS

OF CHURCH FARM, ASTON ABBOTTS

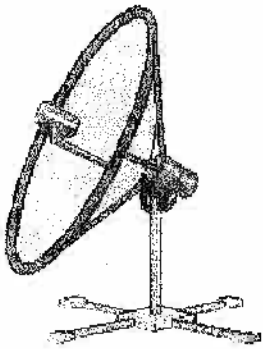

**T.V. VIDEO AND
SATELLITE
SERVICING AND
GENERAL REPAIR**

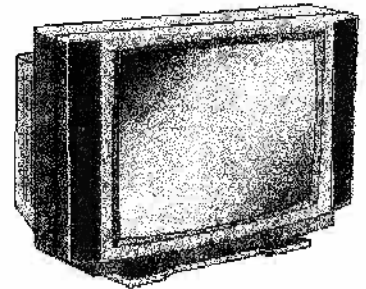

**NEW AND USED SALES
LCD, PLASMA, DVD**

**01296
682126**

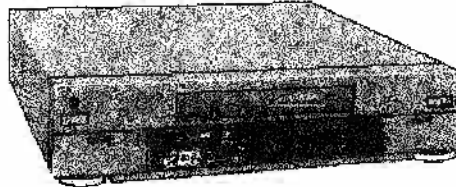

**01296
682126**

HAVE YOU SEEN THIS MAN?

Villagers are being asked to keep a careful look out for the evil creature pictured on the right.

On the night of Friday December the 22nd 2006 this man fled the Doghouse in Broughton Crossing without paying for his Christmas dinner!

His whereabouts are currently unknown, but he was last spotted lurking on the fringes of Aston Abbots trying to interfere with the judiciary.

Members of the public are warned not to approach this man, as he could be outrageous.

POLICE IDENTIKIT PICTURE



Flackwell Electronics - Purveyors of plasma screens to the gentry

FLACKWELL ELECTRONICS

OF CHURCH FARM, ASTON ABBOTTS

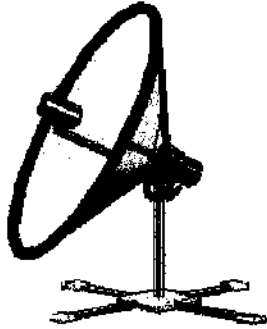

T.V. VIDEO AND
SATELLITE
SERVICING AND
GENERAL REPAIR

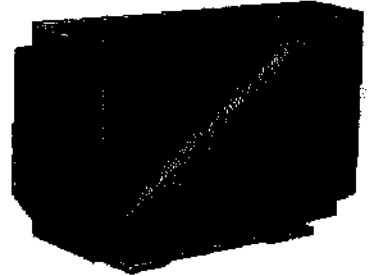

NEW AND USED SALES
LCD, PLASMA, DVD

01296
682126



01296
682126

**POOR DAVE !
HE'S SPENT THE
WHOLE OF
JANUARY IN HIS
WORKSHOP
TRYING TO KEEP
OUT OF
ALISON'S WAY—
AND NOW EVEN
THE TVS ARE
BITING BACK!**

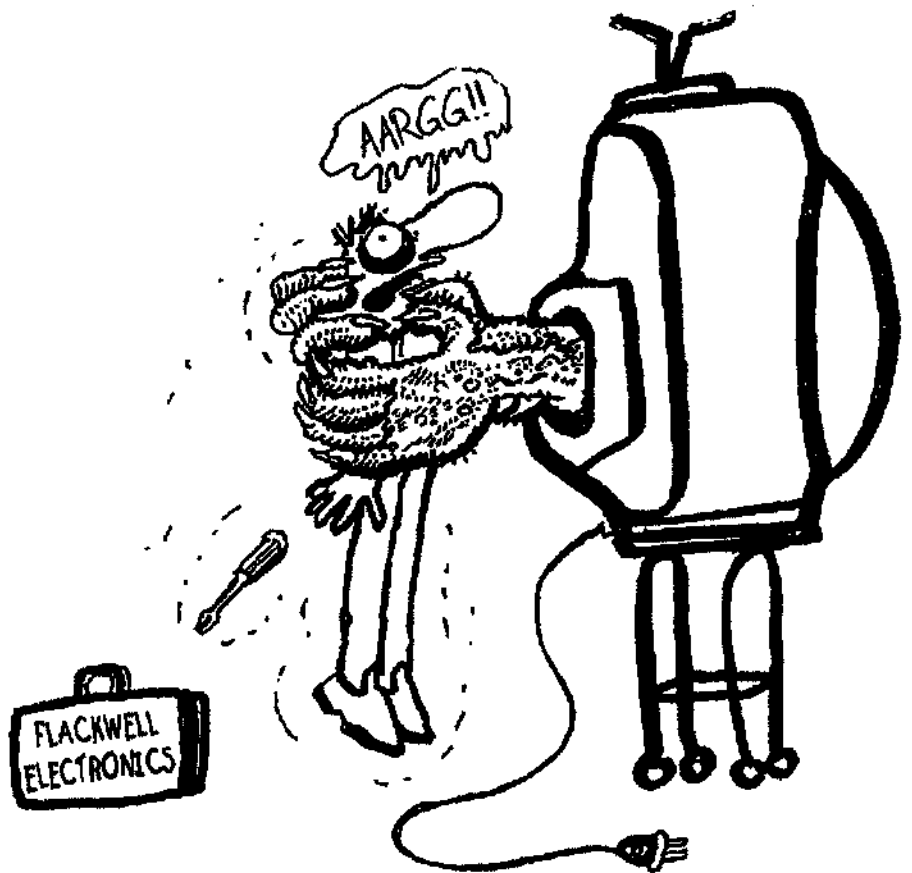

Flackwell Electronics - Purveyors of plasma screens to the gentry

FLACKWELL ELECTRONICS

OF CHURCH FARM, ASTON ABBOTTS

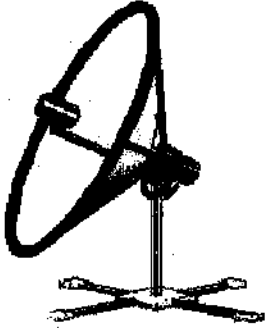

**T.V. VIDEO AND
SATELLITE
SERVICING AND
GENERAL REPAIR**

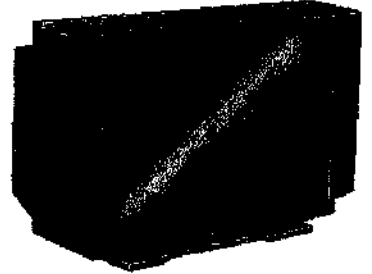

**NEW AND USED SALES
LCD, PLASMA, DVD**

**01296
682126**



**01296
682126**

DAVE'S OFFENSOMETER

Following a period of unusually quiet behaviour from Dave, the Offensometer - the device that measures the general level of offence he causes - remains at a low level, as you can see on the right. To ensure that the statistics are not being fiddled, we invite you to take part in the brief survey below.

How many times has Dave spilled red wine in your house (please restrict your answer to between 5 & 100)?

How many nights has Dave remained late in your house tunelessly singing Bee Gees records long after you have gone to bed?

Has Dave ever removed his trousers in your presence (circle the answer that applies)?
**YES / NO
I NEVER NOTICED**

Which parts of your body have been touched inappropriately by Dave (continue on a separate sheet if necessary)?
.....
.....
.....

Your answers will be fed into the offensogrator to correct any discrepancies in the current Offensometer reading. Thank you for taking part in our survey.

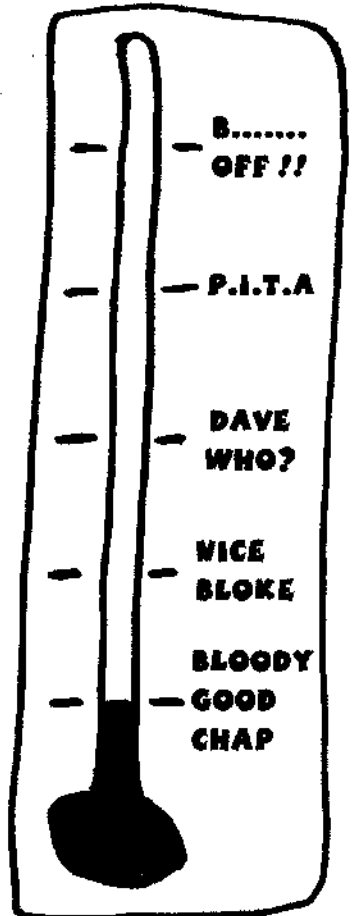

Flackwell Electronics - Purveyors of plasma screens to the gentry

FLACKWELL ELECTRONICS OF CHURCH FARM, ASTON ABBOTTS

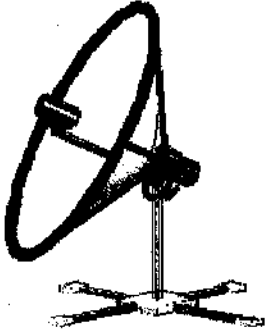

**T.V. VIDEO AND
SATELLITE
SERVICING AND
GENERAL REPAIR**

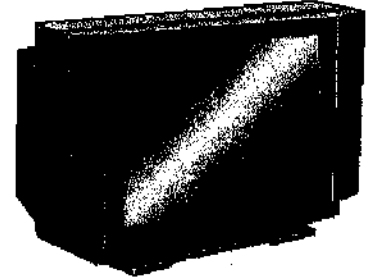

**NEW AND USED SALES
LCD, PLASMA, DVD**

**01296
682126**



**01296
682126**

The Defloration of Neil Chesher

nirvana [nir-vah-nuh]

noun

1. Hinduism Emancipation from ignorance and the extinction of all attachment.
2. A place or state characterized by freedom from or oblivion to pain, worry, and the external world.
3. **An ideal condition of peace, harmony, stability, or joy.**

Throughout our lives many of us grapple with the growing suspicion that there may be more to life and, without really knowing what we are looking for, strive to find that extra something. For some it may be spiritual, for others possibly physical, even carnal.

We never know quite what it is we are looking for. We never know when we are going to find it. We never know just where we will be when the final attainment takes place.

For Neil Chesher, that place was the Fornovivo restaurant in Tring.

As a group of us finished a very pleasant Italian meal we became aware of a party on a nearby table. A French lady dressed as a Playboy bunnygirl, complete with bunny ears and carrying a large whip, particularly attracted Neil's attention. Unable to contain himself, Neil embarked upon some cheeky banter. Before long the bunnygirl angrily waved her whip at Neil and threatened in her charming French accent, "I will wipe you!" Helpfully some of us attempted to explain that the English word was "whip", not "wipe", but Neil enthusiastically offered up his backside. The enraged bunnygirl stormed over to us. Realising that urgent assistance was required, John Whyte and I each grabbed one of Neil's arms and pinned him face down on an unoccupied table.

And as Neil was held spread-eagled across the restaurant table, having his backside "wiped" by a blond French lady wearing a bunny-girl outfit and high heels, a huge smile of blissful gratification spread from ear to ear.

Neil Chesher had finally found Nirvana.

~ Phil Spooner

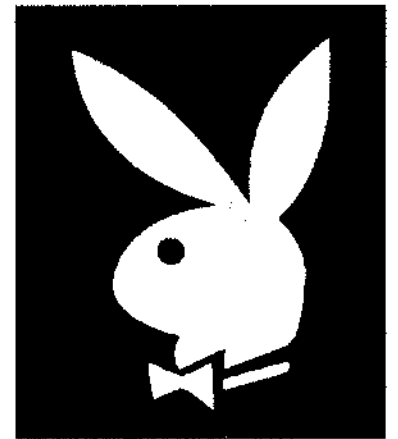

**Dave Lewis
returns to the
back page
next month**

Flackwell Electronics - Purveyors of plasma screens to the gentry

FLACKWELL ELECTRONICS

OF CHURCH FARM, ASTON ABBOTTS

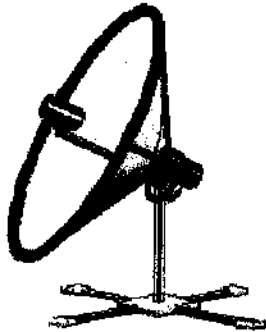

T.V. VIDEO AND
SATELLITE
SERVICING AND
GENERAL REPAIR

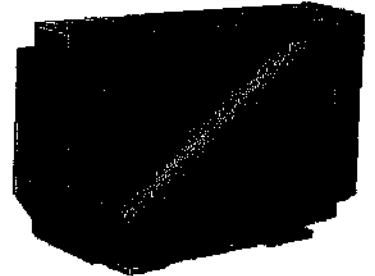

NEW AND USED SALES
LCD, PLASMA, DVD

01296
682126



01296
682126

The Truth About That Broken Toe

We sent our investigative reporter out to discover the true story behind the broken toe suffered by Alison Lewis on a recent holiday in Tobago. Unfortunately he got two different versions of events, so we print both here and leave it to you, the reader, to make up your own minds about what really happened.



Alison's Story

I just don't know how I did it. I had just finished a little light lunch and I thought I might refresh myself by quietly paddling in the shallow water at the sea's edge. Suddenly, I felt a sharp pain in my foot. Looking down I saw my toe sticking out at an odd angle. I must have caught my foot on something.

I'm a trained medical person so I made no fuss, but everybody was most concerned and absolutely insisted upon taking me to the hospital straight away.

The hospital staff were very attentive and impressively thorough, eventually diagnosing a dislocated toe. Then they suddenly wrenched the bones back into position without anaesthetic. That was the worst bit.

Of course, with the pain of the broken toe I was incapacitated for the rest of our time in Tobago. Fortunately I had my darling husband with me and, under my quiet guidance, he was able to take care of those few odd little chores that were quite beyond me because of the pain.

Oh dear, I suffered constantly for the rest of the holiday.

Dave's Story

I just don't know how the silly cow did it. She'd just downed her second lunchtime bucket of rum punch when she suddenly leapt to her feet and charged off into the sea like a demented rhinoceros on heat. There was one rock - just one bloody rock on the whole beach - and she had to go and trip over it!

I've never heard so much fuss. I wanted to leave it until sundown, but she made me miss the afternoon's sunbathing to take her down to the hospital.

The hospital staff were as slow as petrified snails, although they *finally* diagnosed a dislocated toe. Then they suddenly wrenched the bones back into position without anaesthetic. That was the best bit.

Of course, she then laid in a sunbed with her foot up and didn't do a bloody thing for the rest of the holiday. She continually ran me ragged - "Fetch this", "Fetch that", "You had better get me another glass of champagne now".

Bloody Hell! I suffered constantly for the rest of the holiday.

Flackwell Electronics - Purveyors of plasma screens to the gentry

FLACKWELL ELECTRONICS

OF CHURCH FARM, ASTON ABBOTTS

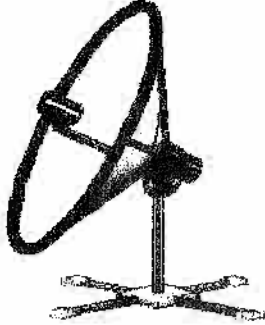

T.V. VIDEO AND
SATELLITE
SERVICING AND
GENERAL REPAIR

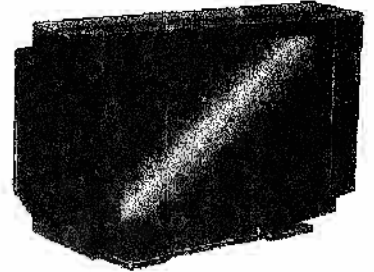

NEW AND USED SALES
LCD, PLASMA, DVD

01296
682126



01296
682126

SEE DAVE 'SPARKS' LEWIS IN ACTION!

Our Chronicle photographer caught resident Aston Abbots sparks and human shock absorber Dave Lewis in action at Astonbury 2006 last year (pictured right).

Be there at **Astonbury 2007** when Dave, wearing only Marigold rubber gloves for protection, will single-handedly divert the entire electricity output of the National Grid into Aston Abbots recreation Ground to power the monster sound system and lights.

This once-in-a-lifetime death-defying feat will take place on **Saturday July 14th**—see elsewhere in The Chronicle for more information—and **be there!**



Flackwell Electronics - Purveyors of plasma screens to the gentry

FLACKWELL ELECTRONICS

OF CHURCH FARM, ASTON ABBOTTS

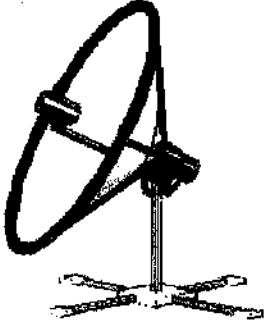

T.V. VIDEO AND
SATELLITE
SERVICING AND
GENERAL REPAIR

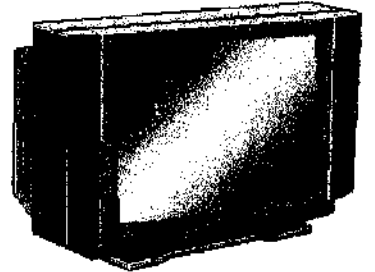

NEW AND USED SALES
LCD, PLASMA, DVD

01296
682126



01296
682126

NOTICE

Visitors to Church
Farm please note
that after July 1st
ALL SMOKERS
will be

SHOT

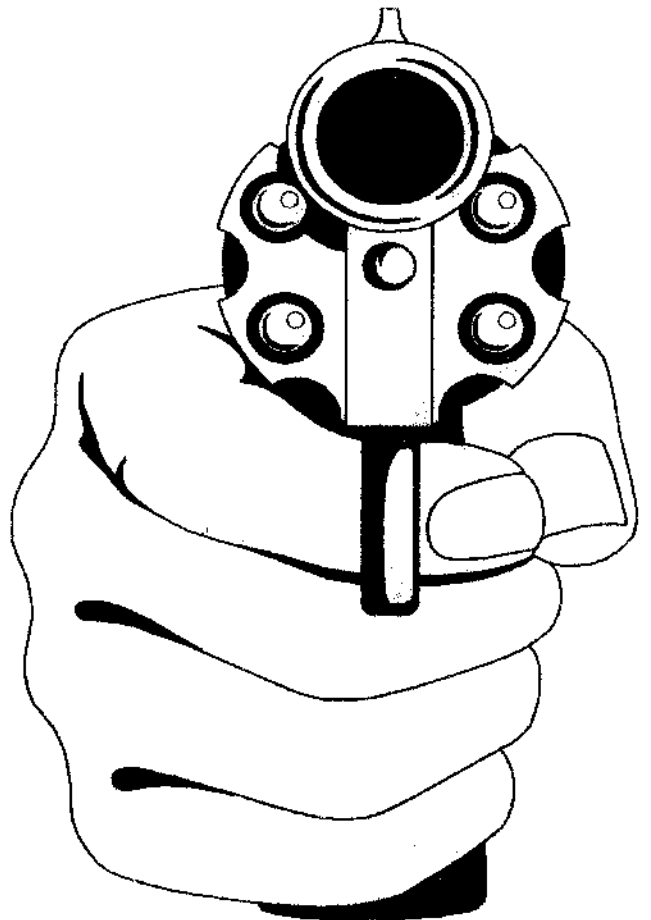

Flackwell Electronics - Purveyors of plasma screens to the gentry

FLACKWELL ELECTRONICS

OF CHURCH FARM, ASTON ABBOTTS



T.V. VIDEO AND
SATELLITE
SERVICING AND
GENERAL REPAIR

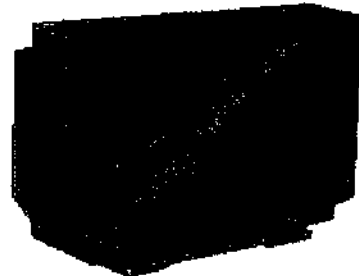

NEW AND USED SALES
LCD, PLASMA, DVD

01296
682126



01296
682126



Flackwell Electronics - Purveyors of plasma screens to the gentry

FLACKWELL ELECTRONICS

OF CHURCH FARM, ASTON ABBOTTS

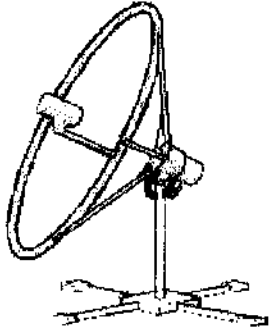

T.V. VIDEO AND
SATELLITE
SERVICING AND
GENERAL REPAIR

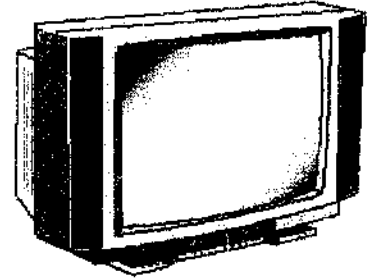

**NEW AND USED SALES
LCD, PLASMA, DVD**

**01296
682126**

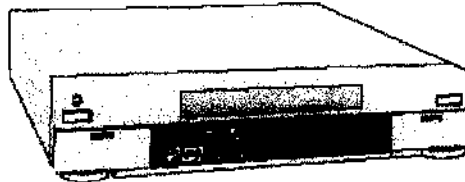

**01296
682126**

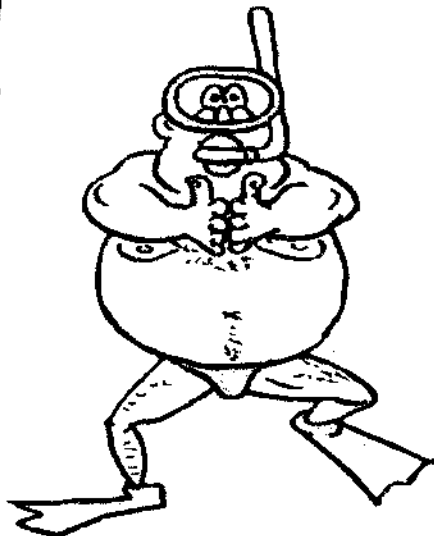
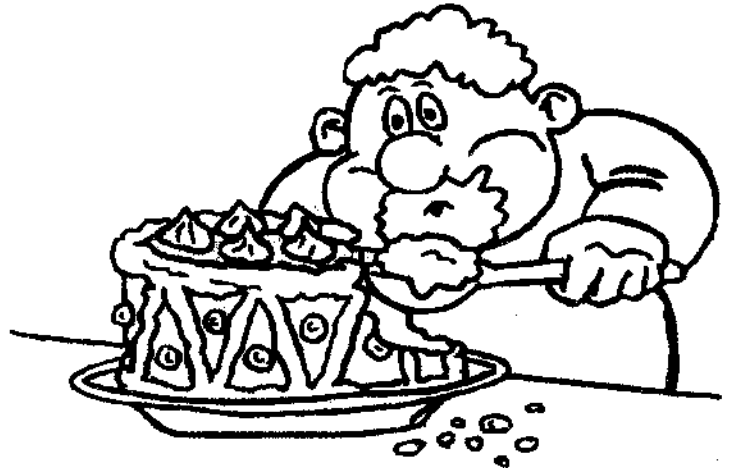

**DIVER DAVE CONTEMPLATES IF
HIS CURRENT EATING HABITS
ARE COMPATIBLE WITH HIS
SPORTING ACTIVITIES AND HIS
REPUTATION AS A VILLAGE
FITNESS ICON.**

Flackwell Electronics - Purveyors of plasma screens to the gentry

FLACKWELL ELECTRONICS

OF CHURCH FARM, ASTON ABBOTTS

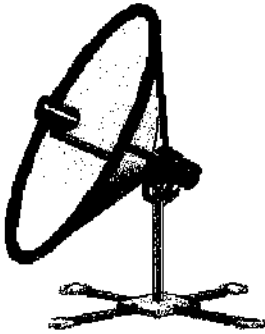

**T.V. VIDEO AND
SATELLITE
SERVICING AND
GENERAL REPAIR**

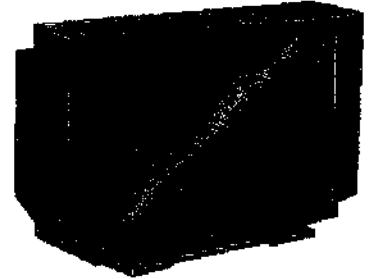

**NEW AND USED SALES
LCD, PLASMA, DVD**

**01296
682126**



**01296
682126**

An Open Letter to *Mr David W Lewis*
from *The Venerable Brethren of Buckinghamshire*

Dear Mr Lewis

With regard to your attendance at our recent Ladies Celebration dinner, may I draw your attention to the following points:

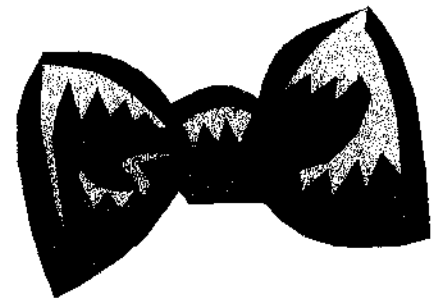

1. Within the invitation request "*Dress Code - Black Tie*" there is a implicit expectation that you will not be wearing **JUST** a black tie. A shirt, jacket and other clothes are also normally worn.
2. When the M.C. announced that he wanted "*to see all members on the dance floor please*" there was a significant and alarming difference between his expectation and your action.
3. During the part of the evening when formal speeches are being made, polite applause, cries of "*hear hear!*" and "*jolly good*", or even possibly drumming one's knuckles gently on the table are appropriate responses. Loud shouts of "*Landlord - more champagne!*" and/or impromptu back somersaults off your chair are not!!!

We hope to see (*a little less of*) you next year.

Thank You

Flackwell Electronics - Purveyors of plasma screens to the gentry

FLACKWELL ELECTRONICS

01296 652126

ALISON AND DAVE

WISH ALL OF THEIR FRIENDS IN ASTON ABBOTTS

A MERRY CHRISTMAS

AND

A HAPPY NEW YEAR

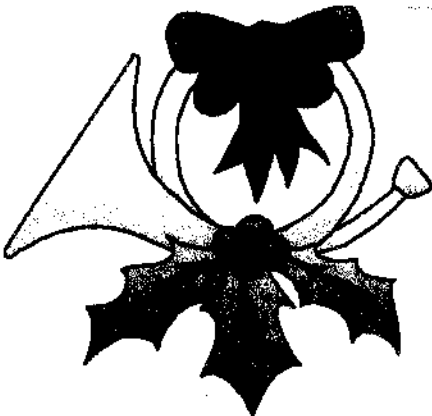

You Know You've Had Too Much Christmas Cheer When...

- 1. You notice your tie sticking out of your fly.
2. Someone uses your tongue for a coaster.
3. You start kissing the portraits on the wall.
4. You see your underwear hanging from the chandelier.
5. You have to hold on to the floor to keep from sliding off.
6. You strike a match and light your nose.
7. You take off your shoes and wade in the potato salad.
8. You hear someone say, 'Call a priest!'
9. You hear a duck quacking and it's you.
10. You complain about the toilet after emerging from the cupboard.
11. You refill your glass from the fish bowl.
12. You tell everyone you have to go home... and the party's at your place.
13. You ask for another ice cube and put it in your pocket.
14. You yawn at the biggest bore in the room... and realise you're in front of the hall mirror.
15. You pick up a roll, and butter your watch.
16. You suggest everyone stand and sing the national budget.
17. You're at the dinner table and you ask the hostess to pass a bedpan.
18. You take out your handkerchief and blow your ear.
19. You tell your best joke to the rubber plant.
20. You realize you're the only one under the coffee table.

'Twas the night before Christmas And all through the house Not a creature was stirring, Not even a mouse.

'Cuzz the cat had pounced on him And tore him apart - Ate his mouse intestines And chewed up his heart.

Kitty thought he heard sleighbells, Which made him take pause - He stopped daintily licking The blood from his claws.

'Must be Santa,' thought Kitty (That quite clever cat) 'Cuz nobody else climbs down The chimney like that.

Indeed it was ol' Santa So jolly and fat With a huge load of presents And all for the cat!

'Wow, the best Christmas ever!' Kitty thought with a purr, Then he coughed up a hairball And shed some more fur!

(Unknown)

Flackwell Electronics - Purveyors of plasma screens to the gentry

FLACKWELL ELECTRONICS

OF CHURCH FARM, ASTON ABBOTTS

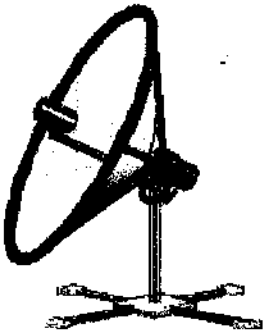

T.V. VIDEO AND
SATELLITE
SERVICING AND
GENERAL REPAIR

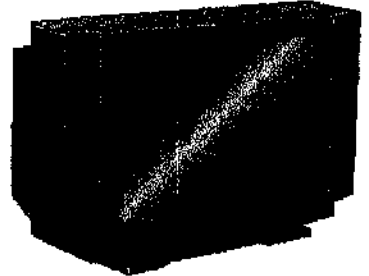

NEW AND USED SALES
LCD, PLASMA, DVD

01296
682126



01296
682126

FLACKWELL STRIPPERGRAMS

Make your party go with a Zing!!!!

Rent our top quality sexy male strippergram for a real surprise. No event too big or too small. Economical rates. Satisfaction guaranteed.

Testimonials

Mr Kevin C. of Aston Abbotts says,

"Unbelievably cheap! I ordered a Flackwell Strippergram for my wife's birthday—I just pressed a glass of white wine in his hand and he started straight away."

Mrs Jane C. of Aston Abbotts says,

"Suddenly this strange man appeared in the middle of our kitchen and started tearing his clothes off. It was an incredible surprise. I thought he was there just to fix the TV set!"



GET DOWN! GET NAKED! GET DAVE! TODAY!

Flackwell Electronics - Purveyors of plasma screens to the gentry

FLACKWELL ELECTRONICS

OF CHURCH FARM, ASTON ABBOTTS

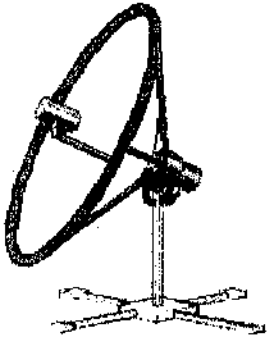

T.V. VIDEO AND
SATELLITE
SERVICING AND
GENERAL REPAIR

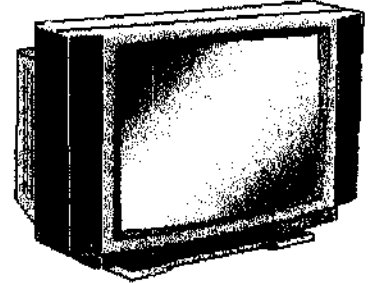

NEW AND USED SALES
LCD, PLASMA, DVD

01296
682126

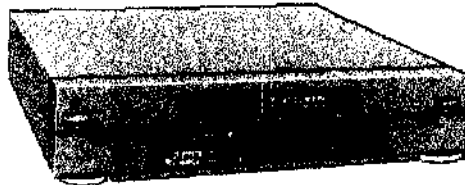

01296
682126

RESULT !!!!!

Our most earnest congratulations to Mr David Lewis who achieved the impossible at Christmas just gone. It is reported that for the first time in at least ten years he managed to tick all three boxes :

- He managed to buy Alison the right *thing* !
- He managed to buy Alison the right *colour* thing !
- He managed to buy Alison the right colour thing and *it wasn't taken back to the shop after Christmas* !¹

We who also suffer salute you!
Well done Dave!

¹Statement correct at time of going to press



Flackwell Electronics - Purveyors of plasma screens to the gentry

FLACKWELL ELECTRONICS

OF CHURCH FARM, ASTON ABBOTTS

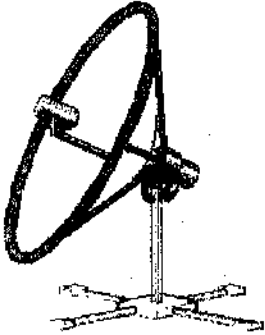

T.V. VIDEO AND
SATELLITE
SERVICING AND
GENERAL REPAIR

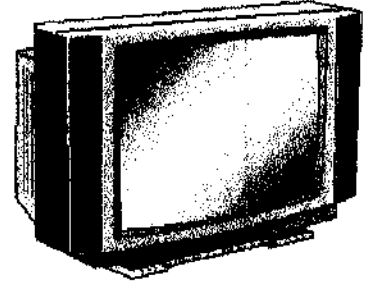

NEW AND USED SALES
LCD, PLASMA, DVD

01296
682126

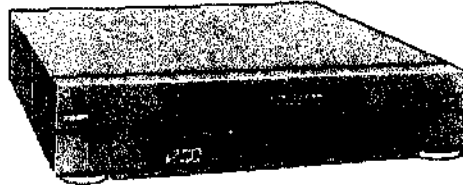

01296
682126

ANTIPODEAN ADVENTURES PTY

CERTIFICATE

AWARDED TO

Mr David W Lewis

FOR ATTAINING A MASTER'S DEGREE IN

Australian Sunstroke

WITH SPECIAL HONOURS IN THE SUBJECTS OF

Sunbathing 1, Alcohol, Sunbathing 2, Shaving, Projectile Vomiting (First Class)

AWARDED BY

A. Pommitwat

Flackwell Electronics - Purveyors of plasma screens to the gentry

FLACKWELL ELECTRONICS

OF CHURCH FARM, ASTON ABBOTTS

01296	TV—DVD—PLASMA—	01296
682126	LCD—HDTV	682126
SALES AND SERVICING		

Dave Lewis Hit By Budget

Alistair Darling's first budget has hit hard at Church Farm. Mr Dave Lewis explains, "The 14p tax increase on a bottle of champagne is monstrous. I can no longer afford to go out on a Saturday. It's grossly unfair! It's added an extra 56p to my average Saturday nights' champagne consumption. And it's added nearly a pound to my wife's Saturday night bill. It's an attack on the drinking classes!"

In a separate and apparently unconnected development Mr Lewis denies that his announcement of a 50p surcharge on all Plasma Television sales is purely a

revenue-raising measure. "It's absolute nonsense. It's not about me getting extra cash at all. We live in a society where people watch too much television—binge viewing—and I have a responsibility to prevent such excess. I'm fed up with seeing people lying around on couches watching TV all over Aston Abbotts. The measure I have announced today will make people think before they watch. It's definitely not a rise in taxation."

(Mr Lewis was speaking from his holiday home on the Great Barrier Reef.)

~ *Chronicle Financial Reporter*



SATURDAY JULY 19TH



WWW.ASTONBURY.BIZ

FLACKWELL ELECTRONICS

OF CHURCH FARM, ASTON ABBOTTS

01296
682126

TV—DVD—PLASMA—
LCD—HDTV
SALES AND SERVICING

01296
682126

DLP Principles Adopted in SA

Many months ago we revealed how the DLP (Dave Lewis Party) was planning for government by revolutionising the way we deal with criminals in our society, putting emphasis on the rights of the victim and protection of the public. The back page article provoked a huge swell of support amongst Chronicle readers.

Now we are pleased to report that Dave's founding political principles are being adopted as government policy in South Africa. The clipping from the Daily Telegraph of the 10th April reproduced on the right shows just how widely Dave's ideas have spread.

Baggage Chaos at Church Farm Helipad

Aston Abbots flying boss Dave Lewis ended up with egg on his face last week as chaos descended at the Church Farm Helipad. Following his installation of a new windsock earlier in the month Dave was forced to admit that there had been baggage handling problems with the first flight this year.

"Although we have spent months in preparation and rehearsals for this day, it appears that we may have lost the bag," admits Dave.

Dave was careful to make sure that the buck did not stop with him. "It's the fault of my staff," he said, adding, "I blame that bag." Mrs Lewis was not available for comment.



Kill the criminals, minister tells police

By Sebastian Berger
in Johannesburg

SOUTH Africa's deputy security minister has told police how to tackle rampant crime in their cities: "Kill the bastards", and do not worry about regulations.

"You must kill the bastards if they threaten you or the community," Susan Shabangu told a police forum in Pretoria. "I want to assure the police station commissioners and policemen and women that they have permission to kill these criminals.

"You must not worry about the regulations. That is my responsibility. Your responsibility is to serve and protect," she added.

"I won't tolerate any pathetic excuses for you not being able to deal with crime. You have been given guns, now use them. I want no warning shots. You have one shot and it must be a kill shot."

South Africa has one of the highest crime rates in the world, with more than 19,000 people murdered last year — more than 50 a day.

Thabo Mbeki's ANC government has long been accused of failing to tackle crime, but Jacob Zuma, the party's populist new leader, has called it a "national emergency".

Many South Africans welcomed Miss Shabangu's comments. "Hooray... finally," wrote one website contributor. "Hopefully it will make those bastards think twice."

The opposition Democratic Alliance called for the deputy minister to be sacked.

Flackwell Electronics—Please buy yer tellies from Dave

FLACKWELL ELECTRONICS

OF CHURCH FARM, ASTON ABBOTTS

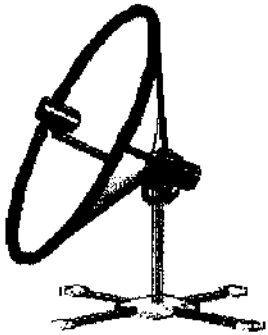

T.V. VIDEO AND
SATELLITE
SERVICING AND
GENERAL REPAIR

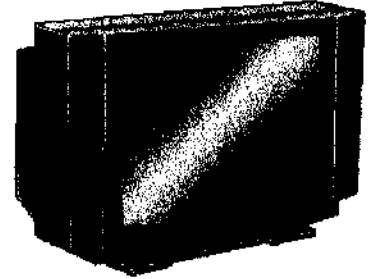

**NEW AND USED SALES
LCD, PLASMA, DVD**

**01296
682126**

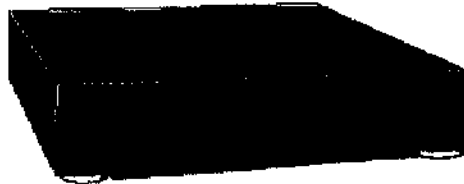

**01296
682126**

An Aston Abbots Welcome

It is a matter of some pride that here in Aston Abbots we like to extend a warm welcome to visitors from other villages. So, when one of Aston Abbots' glitterati chose to introduce Anne, a lady friend from Oxfordshire, we did our best to make her feel welcome. It was, perhaps, rather unfortunate that this introduction took place at *Dodgy Dave's Deviant Dinner* party.....

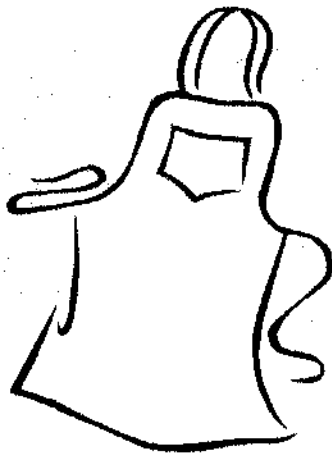

So, Anne, I address the rest of these remarks to you. Firstly, you should realise that it was not at all unusual that your waiter suddenly appeared at the dinner table absolutely stark naked, except for a small plastic pinafore. Fortunately, as you will have no doubt noticed, owing to the fact that we were

eating outside and the temperature was getting rather cold, there was actually very little to be alarmed about.

Furthermore, although you left surprisingly early I wish to reassure you that there is no truth in the rumour that late in the evening a well-known Astonbury singer was seen miming Elvis Presley's *Suspicious Minds*, using a ten inch rubber, err..., "toy" as a microphone.

However, it might be true that a certain Gnome, presented with a cheeseboard, failed to notice the aforementioned "toy" nestling amongst the grapes and tried to cut a slice off it whilst declaring a fondness for mozzarella.

Welcome to Aston Abbots Anne. We hope you enjoyed your visit and you'll come back and see us again soon.

Remember - See Dodgy Dave for all of your entertainment needs (we also do Plasma, LCD TV, DVD and video).

Flackwell Electronics - Purveyors of plasma screens to the gentry

FLACKWELL ELECTRONICS

OF CHURCH FARM, ASTON ABBOTTS

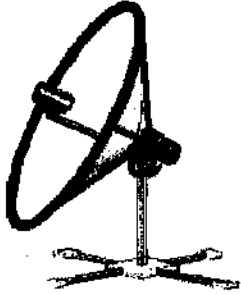

T.V. VIDEO AND
SATELLITE
SERVICING AND
GENERAL REPAIR

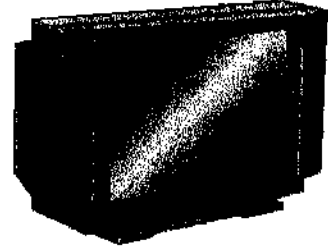

NEW AND USED SALES
LCD, PLASMA, DVD

01296 682126

Robert Mugabe to seek asylum in Aston Abbots?

Aston Abbots Parish Council has moved quickly to dispel rumours that Zimbabwean president Robert Mugabe is to seek political asylum and premiership in Aston Abbots. Speculation had been rife since Mr Mugabe accompanied Mrs Alison Lewis to Dierdre Whyte's 50th birthday party.

Fearing the worst Aston Abbots residents braced themselves for an inflation-busting one million percent increase in Parish Council precept. However, at the time of going to press an increase has yet to be announced.

We are not sure how Mr Mugabe reacted when he was made aware of the limited tax-raising power of the Parish Council, this being somewhat less than he is used to spending and slightly under a quarter of the current Zimbabwean gross national product. However, later in the party evening it was noticed that Mr Mugabe had become rather pale in the face. At approximately the same time our reporter also noticed that somebody we can only refer to as "F" had developed strange black marks across her chest. We are not in any way suggesting that these two events are linked, but the facts speak for themselves and should lawyers for Mr Mugabe and "F" be reading this we wish to point out that we do have photographic evidence.



Mugabe in Aston Abbots—July 26th 2008

Flackwell Electronics - Purveyors of Plasma Screens to the Gentry

FLACKWELL ELECTRONICS

OF CHURCH FARM, ASTON ABBOTTS

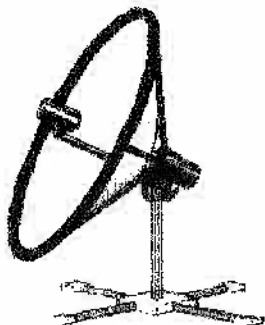

**T.V. VIDEO AND
SATELLITE
SERVICING AND
GENERAL REPAIR**

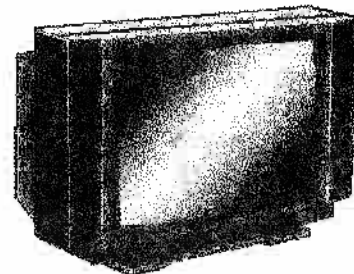

**NEW AND USED SALES
LCD, PLASMA, DVD**

**01296
682126**

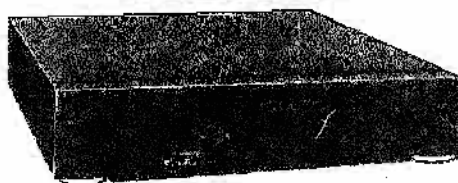

**01296
682126**

Dave's Money-Saving Tip Number 8

When you go on holiday, don't waste money on valet-parking at the airport. Instead of paying extra money to have a driver greet you outside of the terminal with your car when you arrive home, follow this great advice from Dave.

Park in the long-stay car-park. This is much cheaper than valet-parking. But when you return to the airport, you need to avoid the queuing, the tedious bus-ride and the delay. Here's the plan:

1. As soon as you clear customs one of your party leaves the rest in the baggage hall to wait for the baggage
2. This person runs ahead to catch the bus to the car park.
3. This person then collects the car and brings it back to the terminal to meet the rest of the group as they emerge from the terminal.

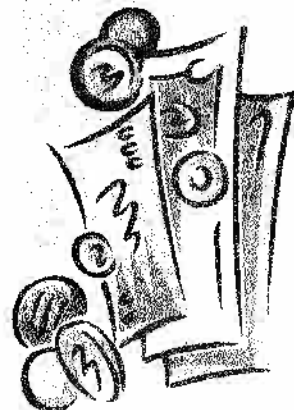

Result: The party get met at the terminal door as they come out without the cost of valet-parking. No wait. No bus ride for the group. It's a simple scheme. It can't go wrong!

Now, here is the important bit. Here Dave reveals the secret ingredient, learnt from his own bitter experience. When the nominated person runs ahead to catch the car park bus and fetch the car, he must... HE MUST... look at the destination written on the front of the bus!

In Dave's case he did eventually arrive back at the terminal (on the same bus) to find the rest of his party dejectedly awaiting his return. Then everybody caught the right bus to the car park... but everybody agreed that they were happy to have saved the extra money on valet-parking!

Flackwell Electronics - Purveyors of Plasma Screens to the Gentry

FLACKWELL ELECTRONICS

OF CHURCH FARM, ASTON ABBOTTS

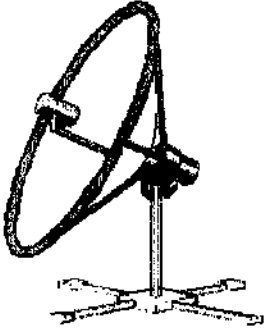

T.V. VIDEO AND
SATELLITE
SERVICING AND
GENERAL REPAIR

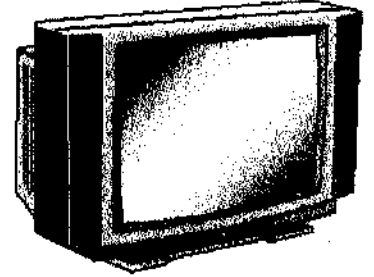

NEW AND USED SALES
LCD, PLASMA, DVD

01296
682126

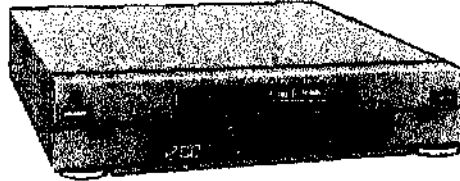

01296
682126

DAVE'S VEILED SECRET

**Dave finds a
sure-fire way
to hide from
Alison—but
would you let
this man into
your home to
fix your TV set?**

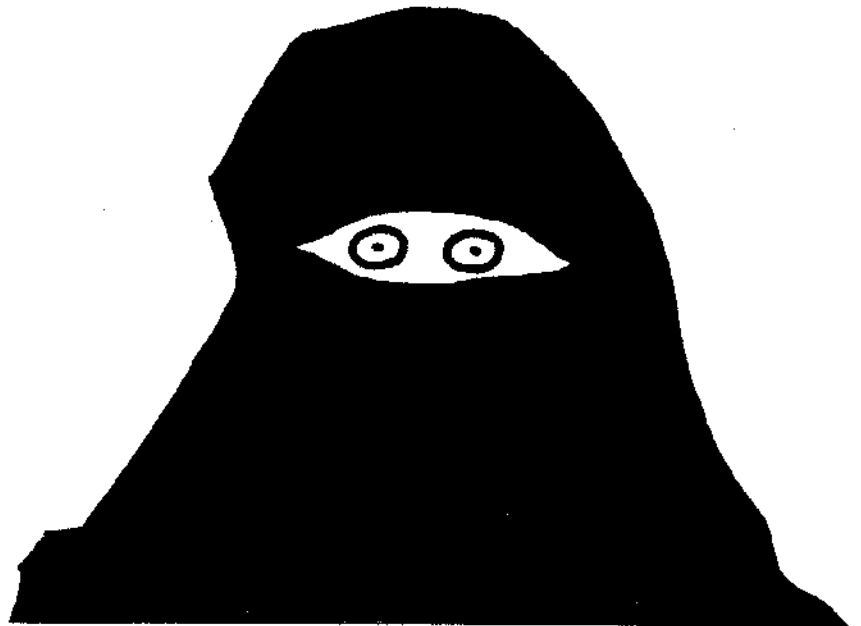

Flackwell Electronics - Purveyors of plasma screens to the gentry

ALISON & DAVE

WISH YOU ALL A

MERRY CHRISTMAS

& A HAPPY NEW YEAR



01296 682126 — Flackwell Electronics — 01296 682126

! DANGER !

KIDS—PRACTICE SAFE SURFING WITH DAVE !

Kids—be safe on the internet! Remember—when your friends send you those funny files by email—you know, the hilarious pictures of the Australian Beach Volleyball team who can only afford half of their costumes, or that funny video with that nice Pamela Anderson lady—do not, I repeat DO NOT, save them to a desktop folder with an obvious name that attracts attention. If you do that—the wicked witch is bound to get you!!!

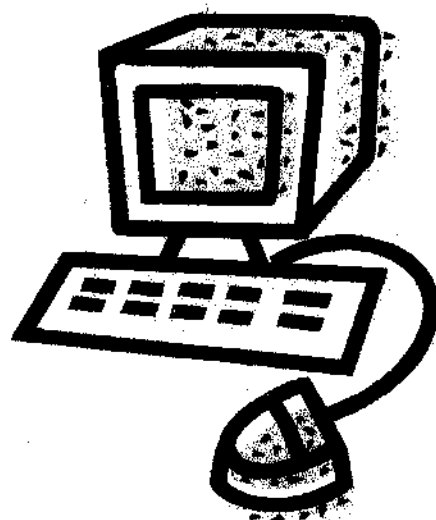

! DANGER !

Flackwell Electronics - Purveyors of Plasma Screens to the Gentry

FLACKWELL ELECTRONICS

OF CHURCH FARM, ASTON ABBOTTS

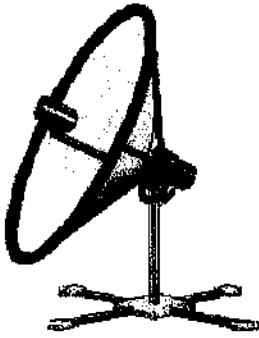

T.V. VIDEO AND
SATELLITE
SERVICING AND
GENERAL REPAIR

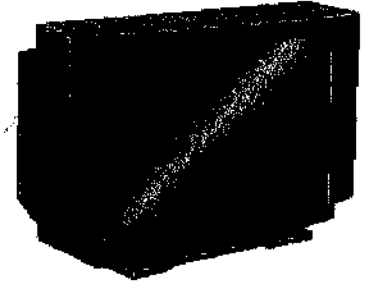

NEW AND USED SALES
LCD, PLASMA, DVD

01296
682126



01296
682126

World Record Success!

Aston Abbots was celebrating a world record success in December, as it became known that Mr David W Lewis of Church Farm had beaten the world record for making the transition from the perpendicular to the horizontal. Mr Lewis achieved his feat at a pre-Christmas cocktail party when he went from standing to comatose in just 45 minutes, ably assisted and encouraged by a motley gaggle of supporters and hangers-on who supplied him with a bevy of unspecified multi-coloured alcoholic drinks.

The other party goers celebrated through the night after the feat, whilst Mr Lewis was placed in his normal recovery position: flat on his back on the sofa, trousers undone, snoring loudly.

Mr Lewis has confidently stated that he can beat his own 45 minute record in the future. Supporters believe he has a good chance, if next time he can be dissuaded from attempting inappropriate physical contact with female guests during the attempt.

~ Chronicle Reporter

Flackwell Electronics - Purveyors of Plasma Screens to the Gentry

FLACKWELL ELECTRONICS

OF CHURCH FARM, ASTON ABBOTTS

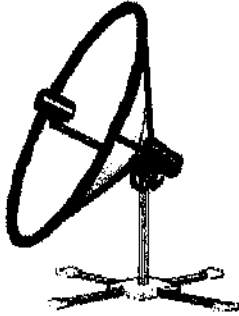

T.V. VIDEO AND
SATELLITE
SERVICING AND
GENERAL REPAIR

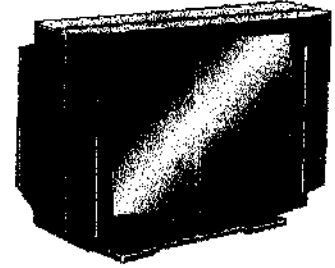

NEW AND USED SALES
LCD, PLASMA, DVD

01296
682126



01296
682126

Lifetime Achievement Award

At this years Aston Abbotts Christmas Show the Annual Awards ceremony was dominated by just one award. A special Lifetime Achievement Award was given to Dave Lewis.

This was meant to be a surprise, but unfortunately Dave clearly got wind of the award because less than two weeks before the ceremony he tried to disguise himself by dying his hair jet-black.

The disguise was almost successful as nobody in the Royal Oak recognised him at first. One well-known villager was so taken in that he asked me, "who is the strange man in the black wig?" and another said, "could that be Elvis?"

On the night, Dave stepped forward to receive his award to tumultuous applause from the packed crowd. Unusually for awards ceremonies these days, Dave did not cry.

Unusually for Dave these days, he kept his trousers on.

Congratulations Dave, on a well deserved award.



Flackwell Electronics - Purveyors of Plasma Screens to the Gentry

FLACKWELL ELECTRONICS

OF CHURCH FARM, ASTON ABBOTTS

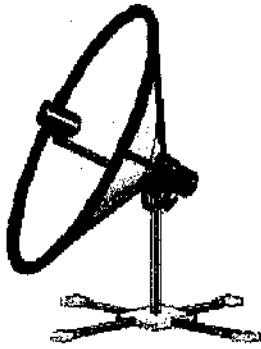

**T.V. VIDEO AND
SATELLITE
SERVICING AND
GENERAL REPAIR**

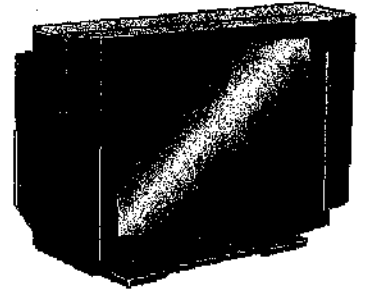

**NEW AND USED SALES
LCD, PLASMA, DVD**

**01296
682126**



**01296
682126**

Back in January 2001 I did my first back page, setting to my task with glee as I did my best to create little jokes based around real-life events in the life of my friend Dave Lewis.

Of course, it was a very different world back in 2001. I was much younger, and Dave's hair was much greyer.

Eight years and around 90 back pages later I have turned those first hesitant cryptic jokes into full-blown character assassination. However, now it feels like its time to put away my barbed pencil and leave the Lewis family in peace.

it might surprise some readers to learn that Dave has actually spent the last eight years

paying the top Chronicle advertising rate for the whole back page, just for the privilege of being publicly insulted every month.

Was it all true? Were those bizarre and sometimes unbelievable stories nothing but a figment of my fertile imagination. Oh no! Not at all - they were all true and I have signed witness statements (no torture involved) and, in some cases, video evidence to prove it all!

So is Dave calming down? As he edges ever closer to his bus pass and Zimmer frame, has time got the better of him? Has he mellowed with age? Not a bit of it! And let's hope he never does!!!

So, for now, that's it! This is ...

THE END

Phil Spooner, February 2009

Flackwell Electronics - Purveyors of Plasma Screens to the Gentry

FLACKWELL ELECTRONICS

OF CHURCH FARM, ASTON ABBOTTS

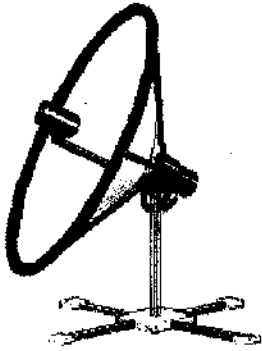

T.V. VIDEO AND
SATELLITE
SERVICING AND
GENERAL REPAIR

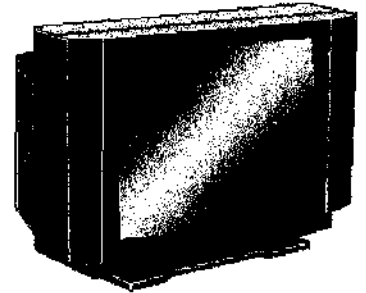

RENTALS, NEW
AND USED SALES

01296
682126



01296
682126

D. WHYTE

Skip Movers

Do you have a building skip in your drive? Would you like it moved to a new position? Using a selection of vehicles our fully experienced operative can move your skip in your drive using her unique and well-practised rapid random reverse gear manoeuvre. It takes only seconds to move your skip.

2 for 1 Special Offer

In case you are not satisfied with your skip's new position, our operative will come back two days later and move it again, using a different vehicle from our special skip-moving fleet.

Satisfaction Guaranteed. All debris and car parts removed from site

Health and Safety Notice: All people within 100 metres of the operation should wear ear defenders.

FLACKWELL ELECTRONICS

OF CHURCH FARM, ASTON ABBOTTS



- **PLASMA**
- **LCD**
- **DVD**
- **HDTV**

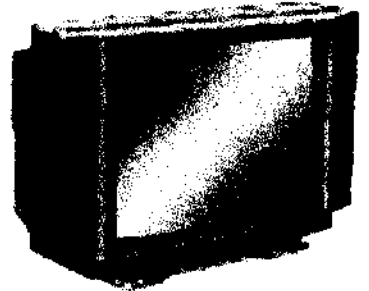

RENTALS, NEW AND USED SALES

01296
682126



01296
682126



LEWISAIR

Following their acquisition of a new fleet of aircraft (or one ninth of an aircraft, at least) LEWISAIR is pleased to announce a new charter service from somewhere near High Wycombe to anywhere you want to go.

JOB OPPORTUNITIES WITH LEWISAIR

LEWISAIR has vacancies for three Flight Attendants

LEWISAIR is an Equal Opportunities employer and this job is available to all regardless of sex, age, size, or religion. However, please note that it is a requirement of the job that you should wear our standard LEWISAIR Flight Attendant's uniform of four inch stiletto heels, black tights, red spandex pants, and a leather basque that is inevitably one size too small.

Please apply in writing, enclosing four photographs and a ten minute video (preferably taken in a beach location), to Mr O. Lewis, Managing Director, LEWISAIR



FLACKWELL ELECTRONICS — PURVEYORS OF PLASMA SCREENS TO THE GENTRY



Merry Christmas
and a happy new year
from
Alison & Dave
Flackwell Electronics



FLACKWELL ELECTRONICS

OF CHURCH FARM, ASTON ABBOTTS

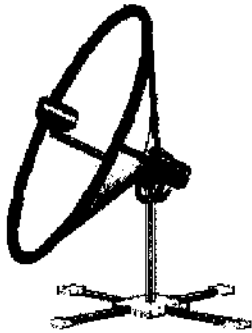

- **PLASMA**
- **LCD**
- **DVD**
- **HDTV**

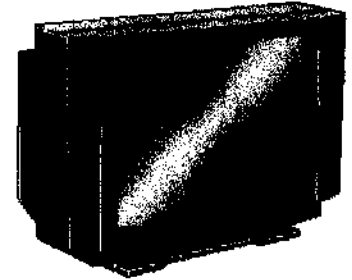

**RENTALS, NEW
AND USED SALES**

**01296
682126**



**01296
682126**

New Year Resolutions for Pets

- | | |
|--|---|
| <ul style="list-style-type: none"> 15. I will not eat other animals' poop. 14. I will not lick my human's face after eating animal poop. 13. I do not need to suddenly stand straight up when I'm lying under the coffee table. 12. My head does not belong in the refrigerator. 11. I will no longer be beholden to the sound of the can opener. 10. Cats: Circulate a petition that sleeping become a juried competition in major animal shows. 9. Come to understand that cats are from Venus; dogs are from Mars. 8. Take time from busy schedule to stop and smell the behinds. | <ul style="list-style-type: none"> 7. Hamster: Don't let them figure out I'm just a rat on steroids, or they'll flush me! 6. Get a bite in on that freak who gives me that shot every year. 5. Break into pantry; decide for MYSELF how much food is <u>too</u> much. 4. Cats: Use new living room sofa as scratching post. 3. January 1st: Kill the sock! Must kill the sock! January 2nd - December 31: Re-live victory over the sock. 2. The rubbish man is NOT stealing our stuff. <p style="text-align: center;">AND the Number 1 New Year's Resolutions
Made by Pets...</p> <ul style="list-style-type: none"> 1. I will NOT chase the stick until I see it
LEAVE THE IDIOT'S HAND |
|--|---|

FLACKWELL ELECTRONICS — PURVEYORS OF PLASMA SCREENS TO THE GENTRY

FLACKWELL ELECTRONICS

OF CHURCH FARM, ASTON ABBOTTS

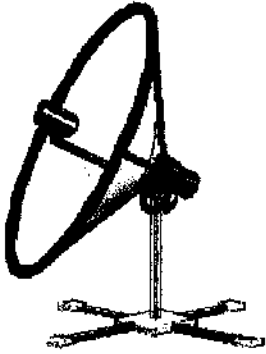

- **PLASMA**
- **LCD**
- **DVD**
- **HDTV**

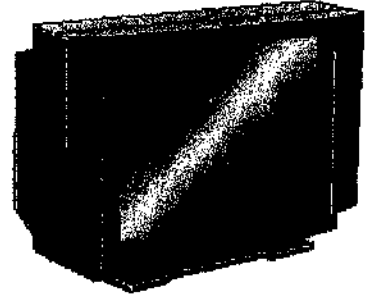

RENTALS, NEW
AND USED SALES

**01296
682126**



**01296
682126**

A Victory For Common Sense

When Munir Hussain was given early release from prison with a much reduced sentence after being jailed for using a cricket bat to beat a knife-wielding burglar who threatened his family there were quite a few who called it a 'victory for common sense'.

However, one villager, whose politics are somewhat to the right of Genghis Khan's, was outraged by Mr Hussain's release. Hearing the subject aired on the Jeremy Vine radio show he immediately send off an angry email to the show. "I don't think Mr Hussain should have been released at all," he raged, "for the simple reason that he failed to finish the b****r off!". The email was not aired. Now who could that villager have been, I wonder?

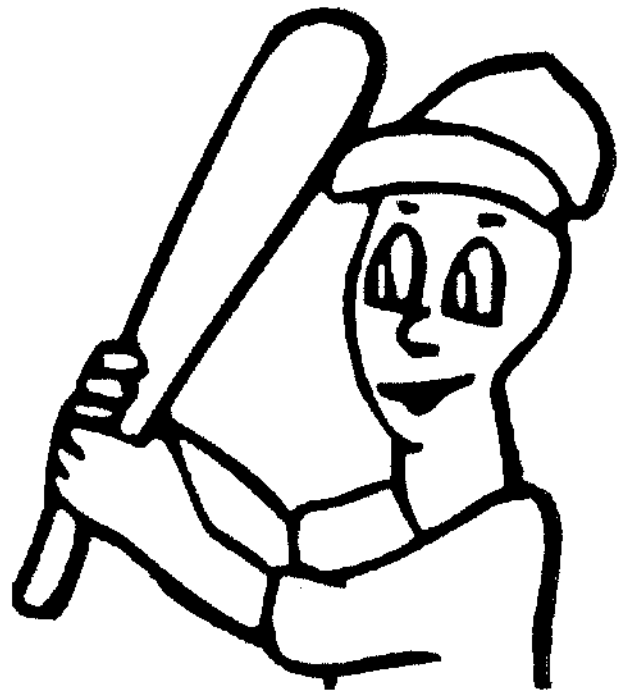

*M. Hussain
(artist's impression)*

FLACKWELL ELECTRONICS — PURVEYORS OF PLASMA SCREENS TO THE GENTRY

FLACKWELL ELECTRONICS

OF CHURCH FARM, ASTON ABBOTTS

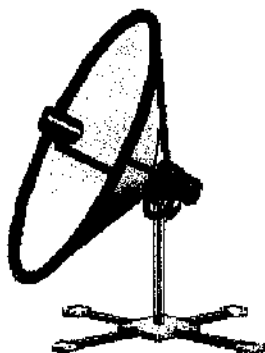

- **PLASMA**
- **LCD**
- **DVD**
- **HDTV**

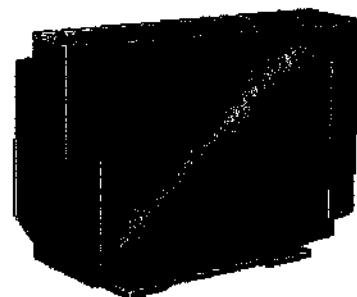

**RENTALS, NEW
AND USED SALES**

**01296
682126**



**01296
682126**

Imponderables

1. If you take an Oriental person and spin him around several times, does he become disoriented?
2. If people from Poland are called Poles, why aren't people from Holland called Holes?
3. Do infants enjoy infancy as much as adults enjoy adultery?
4. If a pig loses its voice, is it disgruntled?
5. If love is blind, why is lingerie so popular?
6. Why is the man who invests all your money called a broker?
7. When cheese gets its picture taken, what does it say?
8. Why is a person who plays the piano called a pianist but a person who drives a racing car not called a racist?
9. Why are a wise man and a wise guy opposites?
10. Why do overlook and oversee mean opposite things?
11. Why isn't the number 11 pronounced onety one?
12. 'I am' is reportedly the shortest sentence in the English language; could it be that 'I do' is the longest sentence?
13. If lawyers are disbarred and clergymen defrocked, doesn't it follow that electricians can be delighted, musicians denoted, cowboys deranged, models deposed, tree surgeons debarked, and dry cleaners depressed?
14. I thought about how mothers feed their babies with tiny little spoons and forks so I wondered if Chinese mothers use toothpicks?
15. You never really learn to swear until you learn to drive.
16. No one ever says, 'It's only a game' when their team is winning.
17. Ever wonder about those people who spend two pounds apiece on those little bottles of Evian water? Try spelling Evian backwards.
18. If 4 out of 5 people SUFFER from diarrhoea, does that mean that one enjoys it?
19. Why if you send something by road it is called a shipment, but when you send it by sea it is called cargo?
20. If a convenience store is open 24 hours a day, 7 days a week, 365 days a year, why are there locks on the door?

FLACKWELL ELECTRONICS — PURVEYORS OF PLASMA SCREENS TO THE GENTRY

FLACKWELL ELECTRONICS



Can you guess
who this is?

FLACKWELL ELECTRONICS — PURVEYORS OF PLASMA SCREENS TO THE GENTRY

FLACKWELL ELECTRONICS

OF CHURCH FARM, ASTON ABBOTTS

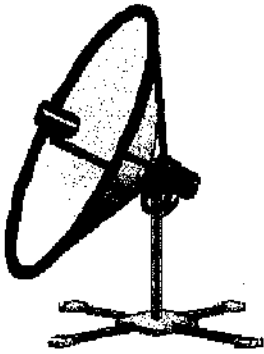

- **PLASMA**
- **LCD**
- **DVD**
- **HDTV**

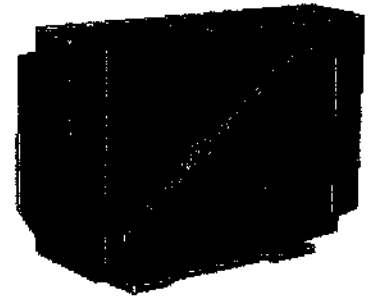

RENTALS, NEW AND USED SALES

01296 682126

Massive Eruption Grounds Dave Lewis

A huge cloud of invisible ash and noxious gasses blew over Aston Abbots from the direction of Cublington in mid April. The airspace around Church Farm was immediately closed to all traffic and Flackwell Electronic's chief pilot Dave Lewis commented that this was the biggest eruption he had known since his wife saw last month's Chronicle back page.

The unexpected airspace closure - the worst in Aston Abbots history - left two well-known Aston Abbots residents stranded in the Royal Oak for several days. One complained, "Das englische Bier ist zu teuer und schmeckt wie Esel Urin - ich habe eine andere Bitte," whilst the other said, "My wife hasn't seen me for ages".

Concerns over a slightly longer than usual drinking session by these two led to an immediate panic amongst members of the 630 Club over the longevity of Aston Abbots beer stocks. Several prominent members were in immediate need of support and an emergency medical team was despatched to provide bottle-to-mouth resuscitation.

~ Val Kano-Ashe

On May 8th - Vote

D L P

Dave Lewis Party

Vote for the party that promotes friendship and goodwill to all. (Except for murderers, rapists, child abusers, and expenses-swindling MPs. For these people we have just one policy : slow, painful, non-anaesthetised castr-

Editor's note: we wish to apologise for a publishing error in the early edition of the May Chronicle. The computer spell-checker replaced the word "Eruption" in the headline of this article with another word beginning with "Er" and ending in "tion". Whilst Mr Lewis was extremely happy with the erroneous headline a source who has asked to remain anonymous told us, "He hasn't had one of those for years!"

FLACKWELL ELECTRONICS — PURVEYORS OF PLASMA SCREENS TO THE GENTRY

FLACKWELL ELECTRONICS

OF CHURCH FARM, ASTON ABBOTTS

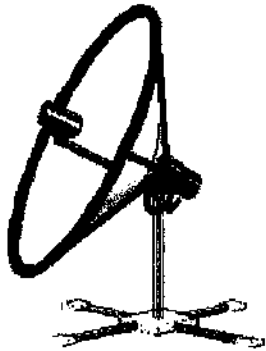

- **PLASMA**
- **LCD**
- **DVD**
- **HDTV**

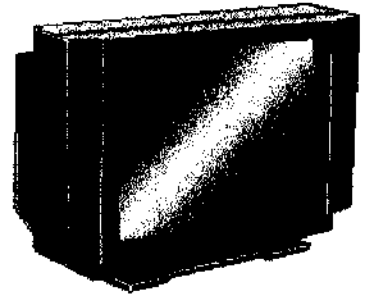

**RENTALS, NEW
AND USED SALES**

**01296
682126**



**01296
682126**

Things to Ponder...

In the 60's, people took acid to make the world weird. Now the world is weird and people take Prozac to make it normal.

Never take life seriously. Nobody gets out alive anyway.

There are two kinds of pedestrians: the quick and the dead.

I used to eat a lot of natural foods until I learned that most people die of natural causes.

Have you noticed since everyone has a cell phone that takes pictures these days no one talks about seeing UFOs like they used to?

Gardening Rule: When weeding, the best way to make sure you are removing a weed and not a valuable plant is to pull on it. If it comes out of the ground easily, it is a valuable plant...

The easiest way to find something lost around the house or shop is to buy a replacement.

Life is sexually transmitted.

Health is merely the slowest possible rate at which one can die.

Health nuts are going to feel stupid someday, lying in hospitals dying of nothing.

Why doesn't glue stick to the inside of the bottle?

Who was the first person to look at a cow and say, "I think I'll squeeze these dangly things here, and drink whatever comes out?"

If quizzes are quizzical, what are tests?

Do illiterate people get the full effect of Alphabet Soup?

Sad News...

We are deeply saddened to report the loss of a well-known and dearly loved village fingernail. Its recent manicuring, lamination and a two-hour painting session failed to prevent the tragic and traumatic loss, which occurred whilst its owner was helping her husband put the cover on his aircraft.

The fingernail was brought back to Aston Abbotts by air and, as a mark of respect, the owner's friends will hold a wake at the wailing wall on the north face of St James' Church on September 1st.

Our sincerest condolences to the bereaved.

No flowers - donations to Country Life and Beauty in Weedon please.

FLACKWELL ELECTRONICS — PURVEYORS OF PLASMA SCREENS TO THE GENTRY

FLACKWELL ELECTRONICS

OF CHURCH FARM, ASTON ABBOTTS

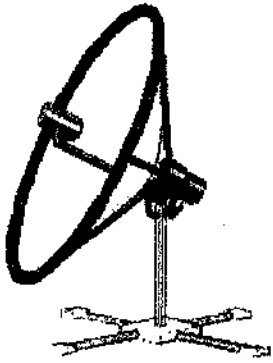

- PLASMA
- LCD
- DVD
- HDTV

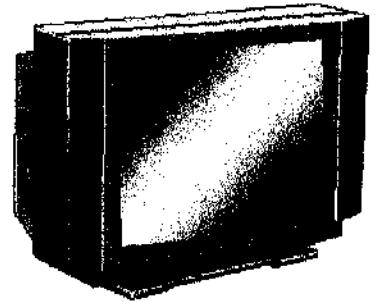

**+ REPAIRS +
NEW AND
USED SALES**

**01296
682126**

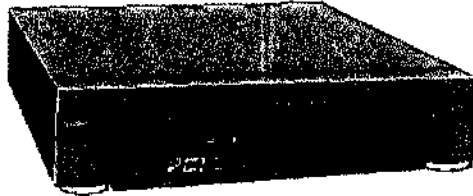

**01296
682126**

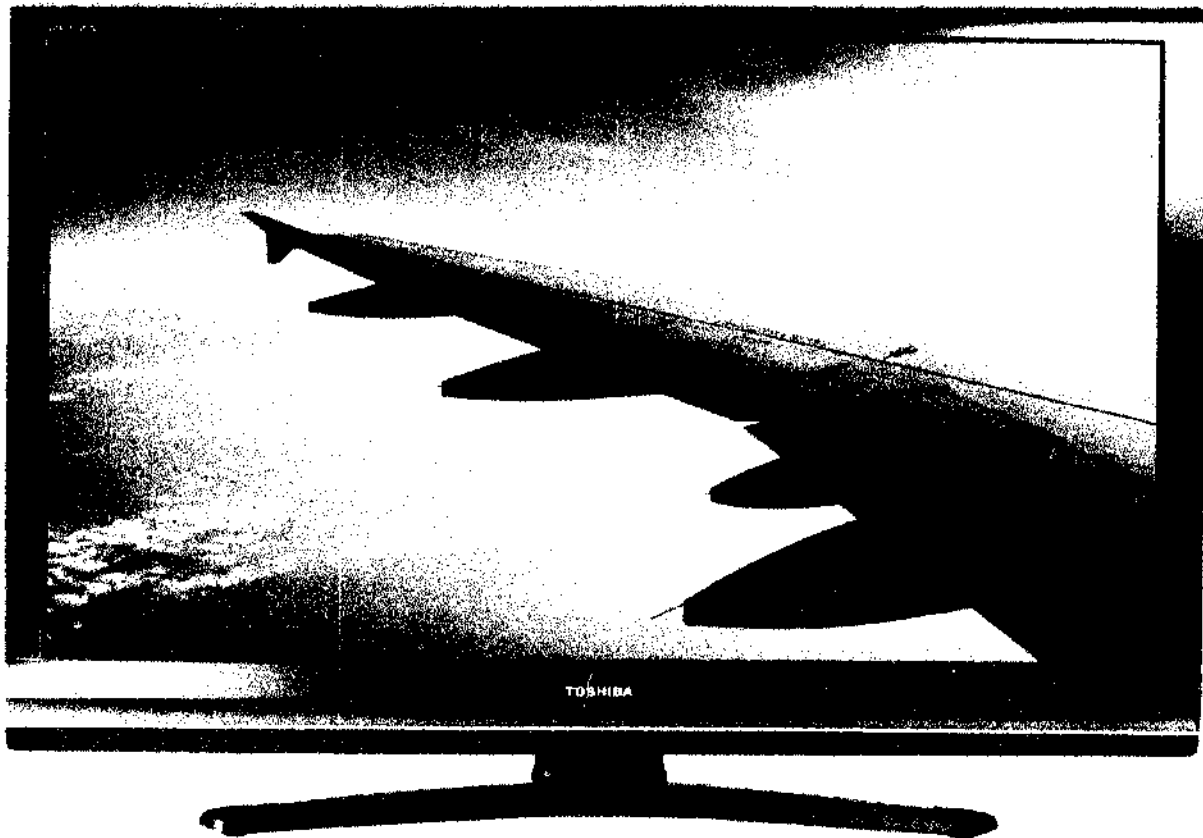

FLACKWELL ELECTRONICS — PURVEYORS OF PLASMA SCREENS TO THE GENTRY

FLACKWELL ELECTRONICS

OF CHURCH FARM ASTON ABBOTTS

- PLASMA
- LCD
- DVD
- HDTV

RENTALS, NEW AND USED SALES

NOW PROUDLY BOASTS ITS SUPER
FAST DELIVERY SERVICE



01296 682126

FLACKWELL ELECTRONICS - PURVEYORS OF PLASMA SCREENS TO THE GENTRY



Merry Christmas

and a happy new year

from

Alison & Dave

Flackwell Electronics

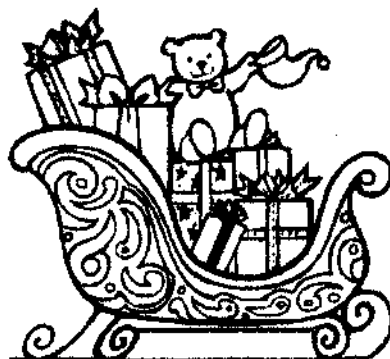

CONGRATULATIONS



In early November Deirdre, John, and Laura Whyte of Bricstoc attended Buckingham Palace where John was presented with the Order of the British Empire—the OBE—by Her Majesty The Queen.

John was awarded the honour in the Queen's Birthday Honours List, the citation reading "John Mills Whyte, lately Director Central Region, UK Border Agency, Home Office".

Congratulations from all of your many friends in Aston Abbots, John.

FLACKWELL ELECTRONICS — BY APPOINTMENT TO JOHN WHYTE OBE

FLACKWELL ELECTRONICS

OF CHURCH FARM, ASTON ABBOTTS

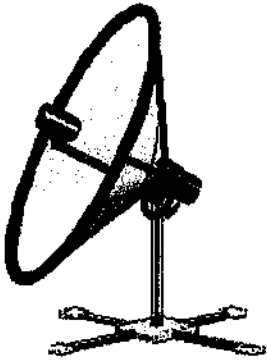

- **PLASMA**
- **LCD**
- **DVD**
- **HDTV**

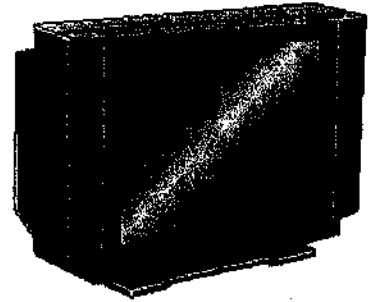

+ **REPAIRS** +
NEW AND
USED SALES

01296 682126

C.F.C.F.C

For some months the **Church Farm Cycling Fitness Club** have met every Saturday morning in an attempt to stave off the dual ravages of age and excess alcohol consumption. The members, which include at least two chunky people, have been undertaking a punishing exercise regime in an attempt to lose weight.

The Saturday regime is as follows:

1. Meet at Church farm with bikes. Inflate bike tyres. Depart for Cublington.
2. Pause *en route* to instruct Astonbury chairman Phil Corrigan on the finer points of changing gear (yet again).
3. Reach Cublington and disembark at The Unicorn. Journey time 7 mins.
4. Enter The Unicorn public house, consume full English breakfast with extra toast and 2 cups of *latte*. Put world to rights.
5. Back on the bikes, cycle home to Aston Abbotts. Time 8 mins. Total exercise time 1½ hours.

Now let's look at the mathematical facts:

FACT: 1 minute of cycling burns 8.85 calories.

FACT: 3500 calories burnt equals one pound of body fat lost.

Therefore: if we do this every Saturday for a year we will each burn $15 \times 8.85 \times 52$ calories and we will each lose nearly two pounds of excess body weight!

The conclusion is inescapable. Come on chaps let's stick to the regime and show them that we can do it!!!

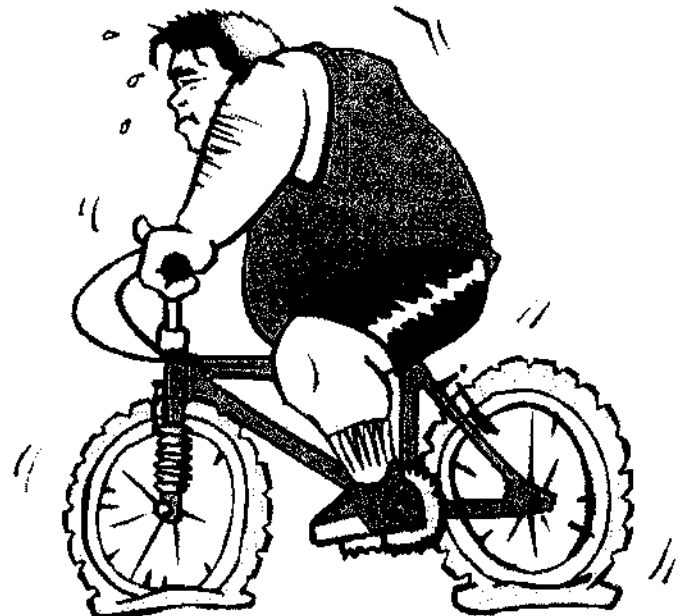

FLACKWELL ELECTRONICS — PURVEYORS OF PLASMA SCREENS TO THE GENTRY

FLACKWELL ELECTRONICS

OF CHURCH FARM, ASTON ABBOTTS

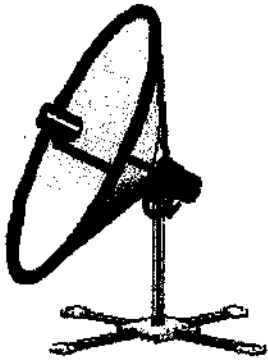

- **PLASMA**
- **LCD**
- **DVD**
- **HDTV**

**+ REPAIRS +
NEW AND
USED SALES**

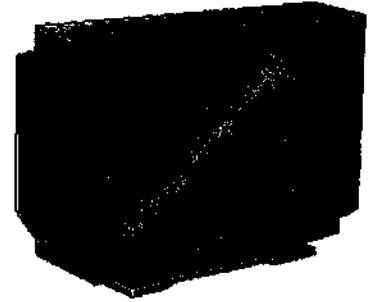

01296 682126

*Well this could be the last time
This could be the last time
Maybe the last time
I don't know. Oh no. Oh no.*

ASTONBURY X

JULY 16TH

ASTONIANS Chapter 3

3:1 And it happened thus...

3:2 For there was a man known as David who lived in a small village. And David was of good humour and toiled hard to provide for his family.

3:3 And there came a day when the family of David returned home and their eyes fell upon David through the window of his workshop. And he was motionless in his chair. And his head was thrown back and his mouth was open. And all around was still.

3:4 "He is dead," cried the family. And they left David and entered within their house where they busied themselves getting their tea.

3:5 Time did pass. And thence came a white-haired wise old man called John. And he looked for David and

he saw him still. And John did bang upon the window of the workshop with His hand.

3:6 And suddenly David's body was filled with life. He jumped from his chair. And upon his face was the expression of a man who had just discovered he has nine testicles.

3:7 And David cried out to John, "You have given me life". He knelt at John's feet and said, "Henceforth thou shalt be known as Saint John of Whyte OBE". And Saint John's face was that of an angel. And his heart was filled with the gladness of a man who has thrashed Neil Cheshier at golf thrice in a fortnight.

3:8 And all around were happy.

3:9 Except for the family who wanted their tea.

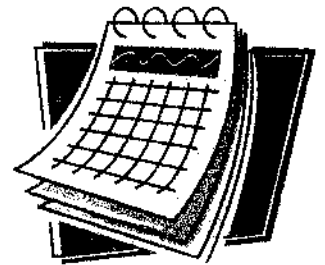

Resolution

In a major effort to keep this New Year's Resolution Dave has vowed to renew it every month throughout 2011. So, is it working? Let's sneak over to Church Farm and listen to Dave renewing it...

JANUARY: I promise not to act so outrageously that I have to sleep in the barn.

FEBRUARY: I promise not to act so outrageously that I have to sleep in the barn.

MARCH: Damn....

FLACKWELL ELECTRONICS — PURVEYORS OF PLASMA SCREENS TO THE GENTRY

FLACKWELL ELECTRONICS

OF CHURCH FARM, ASTON ABBOTTS

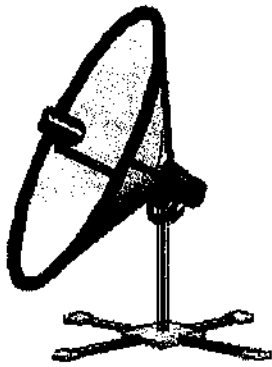

- PLASMA
 - LCD
 - DVD
 - HDTV
- + REPAIRS +
NEW AND
USED SALES**

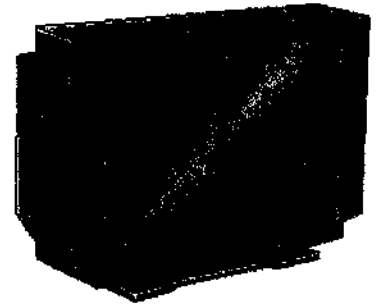

01296 682126

*Well this could be the last time
This could be the last time
Maybe the last time
I don't know. Oh no. Oh no.*

ASTONBURY X

JULY 16TH

Fireman Dave



Now available for hire in Aston Abbots: our fully experienced expert fireman Dave is ready to tackle any blaze.

Book Dave's services next time you are having a fire. He's well practiced and comes with the longest hose and the biggest chopper in the business.

Chip-pan fires are his speciality.

Due to the recent increase in demand for Dave's services we would strongly advise making an advance booking. Please book on the same day for small blazes, but allow at least two days notice for a major conflagration.

No fire - no problem. If you don't have a fire then for a small fee one of Dave's mates will come round and start one.

Note: Following recent events we regret to announce a surcharge of 50% will be levied on all fires after midnight.

FLACKWELL ELECTRONICS — PURVEYORS OF PLASMA SCREENS TO THE GENTRY

FLACKWELL ELECTRONICS

OF CHURCH FARM, ASTON ABBOTTS

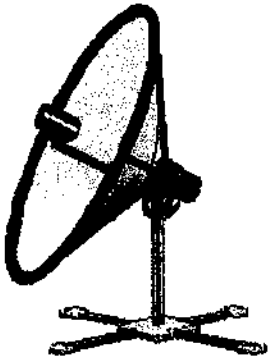

- **PLASMA**
 - **LCD**
 - **DVD**
 - **HDTV**
- + REPAIRS +**
NEW AND
USED SALES

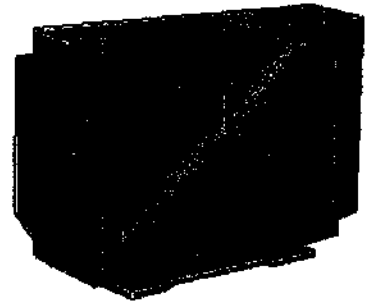

01296 682126

*Well this could be the last time
This could be the last time
Maybe the last time
I don't know. Oh no. Oh no.*

ASTONBURY X

JULY 16TH

Would you **FLY** with a man who put the **WRONG FUEL** in his aircraft?
No way!

Would you **SAIL** with a man who nearly **FELL OFF** his own boat? Not likely!

Would you **CYCLE** with a man who has had 27 lessons in gear changing and **STILL DOESN'T GET IT?** Not a chance!

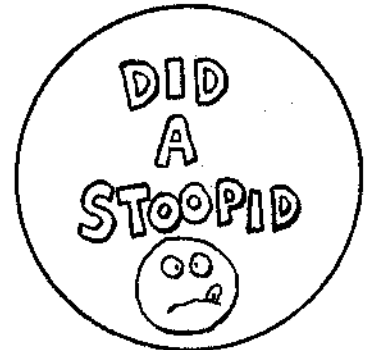

But would you come to a village fun-filled family music festival organised by these men? **OF COURSE YOU WOULD!!!**

This is it! Due to rapidly advancing years the Astonbury organising team are doing it for just one last time and the show on July 16th will be their last. Well, the last for this team as there have been rumours that a younger (but not necessarily prettier) team might just take it on in the future... but for now this is definitely the **LAST TIME**. So come and join us at the Aston Abbots recreation ground on July 16th and party **PARTY PARTY!!!** Look for the advert inside this Chronicle for detail of how **YOU** can get tickets. **SEE YOU THERE!!!**

Disclaimer
In the instance of event cancellation due to terminal senility overtaking the organising team before July 16th we regret that there will be no refunds. This is not because you don't deserve a refund - it's because nobody will be able to remember where the money is.

FLACKWELL ELECTRONICS — PURVEYORS OF PLASMA SCREENS TO THE GENTRY

FLACKWELL ELECTRONICS

OF CHURCH FARM, ASTON ABBOTTS

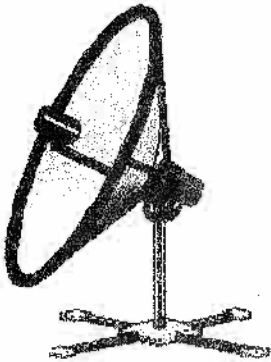

- PLASMA
- LCD
- DVD
- HDTV

+ REPAIRS +
NEW AND
USED SALES

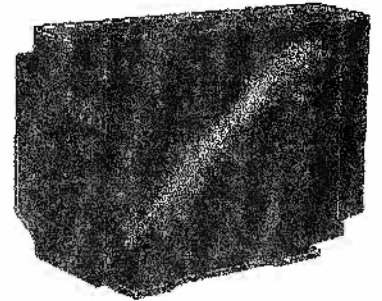

01296 682126

Help The Aged

I guess we all have perceptions of ourselves which appear, with age, to become increasingly separated from reality. I still see myself as the dark-haired thin young man who could possibly pass for James Bond given sufficiently low light. (*Stop scoffing, Lewis!!!*)

The reality is that once in a while, having just got out of bed, startled by catching sight of a strange grey-haired, grey-bearded, quinquagenarian peering out of the bathroom mirror at me, I shriek, "Who the **** is that???"

So I was pleased to find that it is not just me who gets brought down to earth with increasingly frequent age-related reality checks these days...

Our back page hero Dave - he's two years younger than me - was busy rigging the stage for Astonbury when he heard one of the new young upstarts (and we know who you are, we know your name, we know where you live, OK?) say, "I couldn't believe it - one of those *old guys* was right up there on the scaffolding with me!"

Dave fumed quietly for a week over this vicious slur. "*Old guys!!!*" Who does this punk think he is???

A week later Dave was doing a great job at the village fete. He was on the stall where you throw wet sponges at him. Three generations of one family came up; grandfather, father and a little boy of about four years old. The grandfather bought wet sponges for the youngster to throw at Dave, but the boy refused. So the grandfather moved him closer to Dave and said, "Go on, throw it at him." The boy looked down at the ground sullenly and shook his head. So he was moved to about

three feet away. "Go on!" urged the grandfather. The boy just stared at the ground unhappily. "Well," said the grandfather to the father, "You have obviously brought your boy up properly - you have taught him not to throw wet sponges at *grey-haired old men!*" Dave was aghast!!!

My smug satisfaction at Dave's chagrin was soon to be dispelled by something that happened to me a few days later. We took my 91 year old mother-in-law to the theatre for a treat to see Top Hat. It's a 1940s musical that had been a favourite of my Mum and Dad - and mum-in-law likes that sort of thing. As usual, I found myself waiting patiently outside the ladies loo for the female contingent of our party. An elderly gentleman performing a similar vigil struck up conversation with me. Explaining that he had driven up from Kent for the performance he leant towards me and added chummily, "It should be a good show tonight, and of course *it's our era isn't it?*"

Apparently the dead body of a retired man from Maidstone has been found with his head stuffed down the ladies toilet in Milton Keynes Theatre. Police are treating the death as suspicious.

Help the Aged
THE TIME TO CARE IS NOW

FLACKWELL ELECTRONICS — PURVEYORS OF PLASMA SCREENS TO THE GENTRY

Sep 2011 (Iss-313)

FLACKWELL ELECTRONICS

OF CHURCH FARM, ASTON ABBOTTS

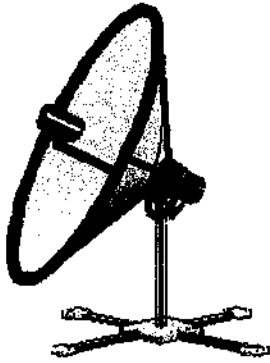

- PLASMA
- LCD
- DVD
- HDTV

**+ REPAIRS +
NEW AND
USED SALES**

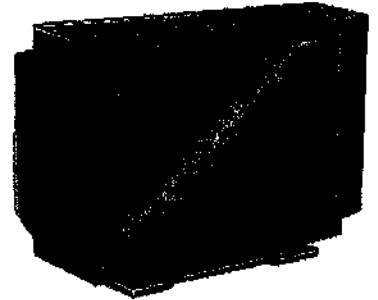

01296 682126

Will the Real Dave Lewis Please Stand Up

Fake Dave Lewis Spotted!

A couple of years ago The Chronicle suggested that Zimbabwean President Robert Mugabe had been glimpsed in Aston Abbotts. The recent Aston Abbotts website update revealed that the much reviled African dictator had recently been seen cruising around Aston Abbotts disguised as David Lewis. See www.aston-abbotts.co.uk/backpage.htm for a picture of this contemptible poseur.

This revelation brought forth a spate of emails claiming confirmed sightings of the imposter. Here is a selection:

Mrs F B: "I was so fooled - I thought it was the real Dave Lewis but this man was just sooooo... naaaauughty"

Mrs D W: "He drank all of our champagne and then wouldn't go home!"

Mrs T H: "He just kept waving a bottle of Baileys at me. Why???"

Ms T D: "I thought he was the real Dave Lewis and I got him to look at my box!"

Caution!!! Do not approach this man. He is extremely congenial and he may give you a very good time! You have been warned!

Panicky quote of the Month:

Mr P Corrigan: "It's the WRONG RUNWAY Dave!!!"

How to spot the real Dave Lewis

The real Dave Lewis is a sober individual who abhors the use of alcohol

The real Dave Lewis attends Church every Sunday and sings in the choir

The real Dave Lewis wrote to Gordon

Brown begging him to stay on because he was doing such a good job

The real Dave Lewis wants an amnesty for all illegal immigrants, travellers, vagrants, and unemployed migrants

The real Dave Lewis has absolutely no interest in tattoos

The real Dave Lewis is often overcome by a relatively small number of bottles of champagne and then enters a catatonic state (although apparently the fake one can do this as well)

If the man you meet does not meet the above criteria then **he is not the real Dave Lewis.**



FLACKWELL ELECTRONICS — PURVEYORS OF PLASMA SCREENS TO THE GENTRY

FLACKWELL ELECTRONICS

OF CHURCH FARM, ASTON ABBOTTS

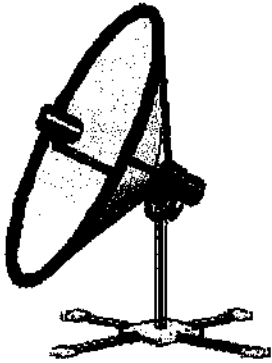

- **PLASMA**
- **LCD**
- **DVD**
- **HDTV**

**+ REPAIRS +
NEW AND
USED SALES**

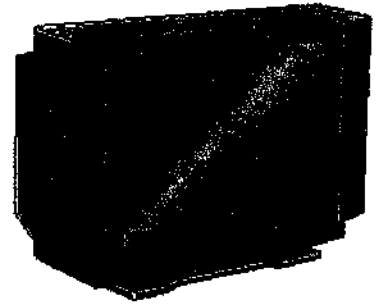
**01296 682126****LewisAir****JOB VACANCY****Air Hostess Required**

LewisAir of Church Farm have an immediate vacancy for an air hostess. Principal duties will include: correct runway identification, filling the plane with the correct fuel, serving champagne to the pilot.

This position would suit a slim attractive young person looking for a challenging hands-on role.

- A working knowledge of the Spanish language will be required.
- Familiarity with foreign customs procedures would be an advantage
- A passable grasp of the English language is always going to be useful, innit?

The successful applicant will enjoy many staff benefits including unlimited Baileys and coffee, a smart company uniform designed by V. Secret, and guaranteed swift automatic membership of the LewisAir mile-high club.

Interested parties should in the first instance apply in writing to D. Lewis. Please include a recent picture of your tattoos.

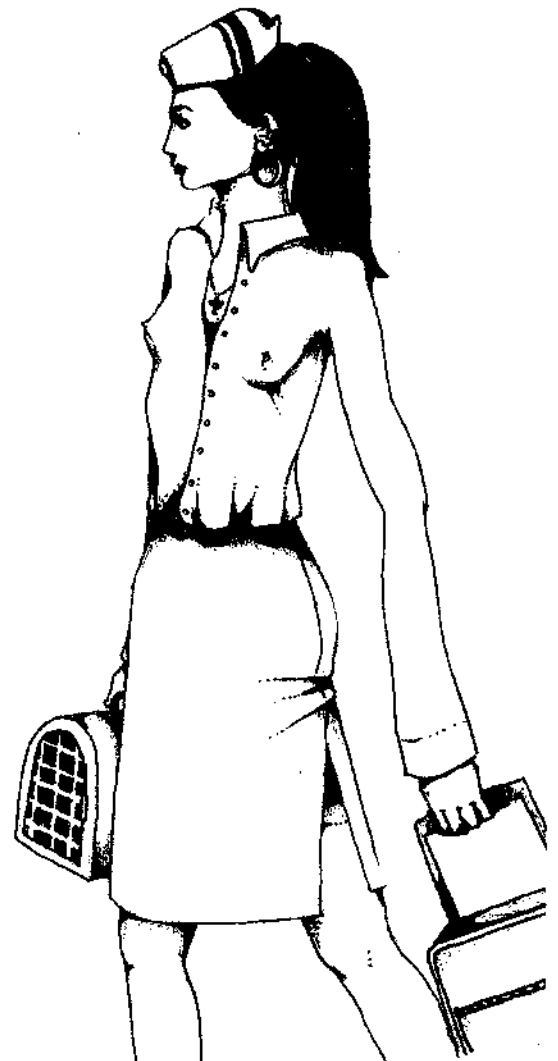
**FLACKWELL ELECTRONICS — PURVEYORS OF PLASMA SCREENS TO THE GENTRY**

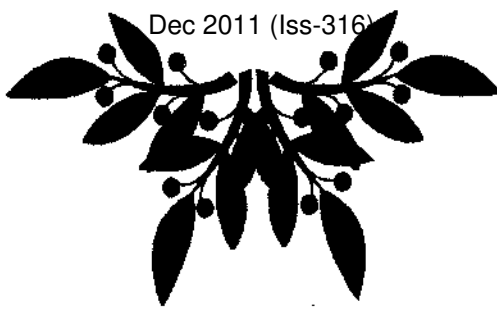

Merry Christmas
and a happy new year
from

Alison & Dave

Flackwell Electronics

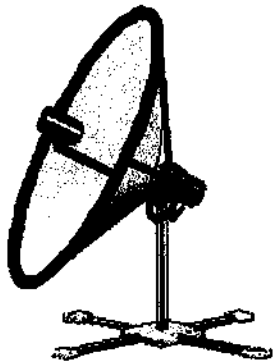

FLACKWELL ELECTRONICS**OF CHURCH FARM, ASTON ABBOTTS**

- **PLASMA**
- **LCD**
- **DVD**
- **HDTV**

**+ REPAIRS +
NEW AND
USED SALES**

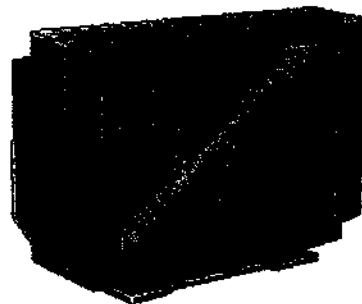
**01296 682126**

FLACKWELL TATTOO INSPECTORS

Are You Legal?

Under new EU legislation which came into force at the end of 2011 anybody in possession of a concealed tattoo must now hold an EU safety certificate.

If you have not yet obtained a certificate then Flackwell Tattoo Inspectors of Church Farm are pleased to offer the services of our fully experienced tattoo inspection Operative Mr D Lewis.

Our Operative will carry out a full and thorough visual inspection of your tattoo and, if he likes what he sees, he will issue you with an EU safety certificate.

Are You Bashful?

If you do not like the idea of this close scrutiny we are pleased to offer a special service for those who find the visual inspection embarrassing. Our Operative will be carefully blindfolded by his assistant Doris. He will then carry out a thorough tactile tattoo inspection using just his fingers. Blindfolded and unable to see your body, his gentle fingertips will glide softly and almost imperceptibly over your tattooed skin. Barely touching, just sensing and probing. Using touch alone our operative will be able to fully determine the safety of your tattoo.

Terms and Conditions

1. Due to the intensive and tantric nature of the tactile inspection this is likely to take seven or eight times as long as the visual inspection.
2. Because of the lengthy nature of the tactile inspection it is recognised that a fee should apply. Our Operative will be pleased to pay you in cash upon completion of his inspection.
3. During the tactile investigation our Operative may start to hyperventilate. This is normal.

FLACKWELL ELECTRONICS — PURVEYORS OF PLASMA SCREENS TO THE GENTRY

FLACKWELL ELECTRONICS

OF CHURCH FARM, ASTON ABBOTTS

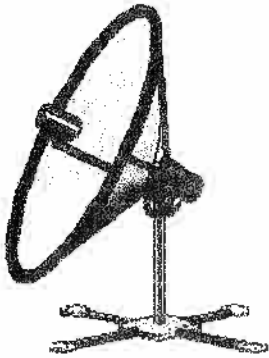

- PLASMA
- LCD
- DVD
- HDTV

+ REPAIRS +
NEW AND
USED SALES

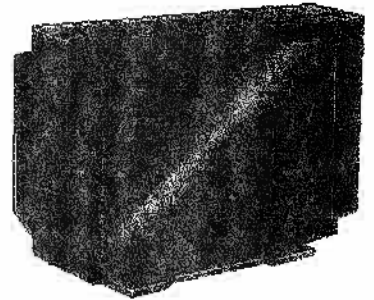

01296 682126

Dave Lewis 'Near The End'

We are very sad to report that Dave Lewis became seriously ill during January. According to a Friday Night spokesman he was at one time 'near to the end'. Although Dave is now recovering after a courageous fight back to health we feel that as a mark of respect we should suspend our normal mickey-taking back page activities. Instead, we reproduce below an internet information leaflet giving public health advice in case one of your loved ones should be struck down in such a terrible way.

MAN FLU---The Facts

1. Man Flu is more painful than childbirth. This is an irrefutable scientific fact*.

(*Based on a survey of over 100,000 men.)

2. Man Flu is not 'just a cold'. It is a condition so severe that the germs from a single Man Flu sneeze could wipe out entire tribes of people living in the rainforest. And probably loads of monkeys too.

3. Women do not contract Man Flu. At worst they suffer from what is medically recognised as a 'Mild Girly Sniffle' which, if a man caught, he would still be able to run, throw a ball, tear the phone book in half and compete in all other kinds of manly activities.

4. Men do not 'moan' when they have Man Flu. They emit involuntary groans of agony that are entirely in proportion to the unbearable pain they are in.

5. Full recovery from Man Flu will take place much quicker if their simple requests for care, sympathy and regular cups of tea are met. Is that really so much to ask? Florence Nightingale would have done it!

6. More men die each year from MFN (Man Flu Neglect) than

lots and lots of other things. (Like rabbit attacks or choking on toast).

7. Men suffering from Man Flu want nothing more than to get out of bed and come to work but they are too selfless to risk spreading this awful condition amongst their friends and colleagues. In this sense, they are the greatest heroes this country has ever known.

8. It is an established fact that the best Man Flu nurses are named Terry, Tracey, or Doris.

9. Man Flu germs are more powerful than He-Man, The Thundercats and The A-Team combined. They are too strong for weak, nasty tasting 'lady medicines' like Lemsip, so don't bother trying to force them on a victim of Man Flu.

10. While it may seem like a Man Flu sufferer is just lying around watching 'Thunderbirds' it is a commonly recognised medical fact that the exact pitch and frequency of Lady Penelope's voice has remarkable soothing powers.

Every minute in this country one man is struck down by Man Flu. Women, all we ask is that each of you offers them a cup of tea, some kind words and your undivided attention and care. Then maybe, just maybe, we'll beat this monstrous disease together.

FLACKWELL ELECTRONICS — PURVEYORS OF PLASMA SCREENS TO THE GENTRY

FLACKWELL ELECTRONICS

OF CHURCH FARM, ASTON ABBOTTS

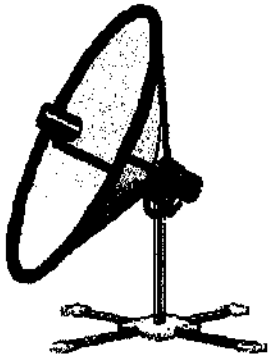

- PLASMA
- LCD
- DVD
- HDTV

**+ REPAIRS +
NEW AND
USED SALES**

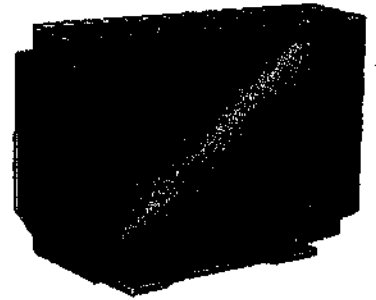

01296 682126

FOR SALE

A Beautiful Dining Room Wall Ornament - hardly used!

This genuine aircraft propeller will add a little *je ne sais quoi* to any home. Nearly six feet in diameter yet standing a mere 18 inches proud from the wall, this is bound to be the main topic of conversation amongst your dinner guests.

Guys - give that special lady in your life that little bit extra. Imagine the look of pleasure, amazement and surprise on her face when she comes back from a Valentines' visit to Spain (without you) and her eyes fall upon this beautiful new addition to her home!

Legitimate reasons for sale include :

1. Unwanted gift
2. Impending divorce



FLACKWELL ELECTRONICS — PURVEYORS OF PLASMA SCREENS TO THE GENTRY

FLACKWELL ELECTRONICS

OF CHURCH FARM, ASTON ABBOTTS

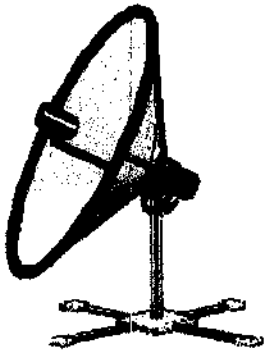

- **PLASMA**
- **LCD**
- **DVD**
- **HDTV**

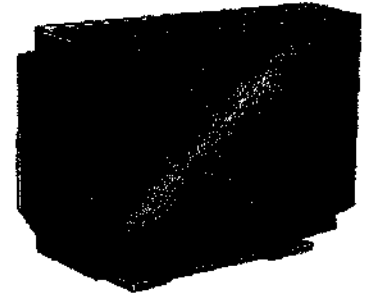

RENTALS, NEW
AND USED SALES

**01296
682126**



**01296
682126**

Police Seek Store Fiend

Police have issued a county-wide alert following a serious incident in a major High Wycombe household retail store. Chief Inspector Flynn told *The Chronicle*, "All young women between the ages of 18 and 85 should be on their guard. It is clear there is a monster on the loose. No-one is safe!"

Witnesses say that a man stealthily approached a young lady standing at the bottom of an escalator and smacked her sharply on the behind. When she swung around in terror he clapped his hand to his forehead, gasped "I thought you were Tracy Hinds", and ran off into the crowd.

Police have described the man they are seeking as being in his mid fifties, with short grey hair. They are unable to confirm reports that the same man was captured on CCTV earlier that day buying a copy of *Aircraft Parts Monthly* in W. H. Smith, and later trying to peer through the back window of a local tattoo parlour.

The police have appealed for other victims of this man who may have suffered similar attacks to come forward. A special call centre has been set up to deal with the expected influx of calls

Police have warned all women not to approach this man, as he may fondle without warning

FLACKWELL ELECTRONICS — PURVEYORS OF PLASMA SCREENS TO THE GENTRY



AWARDS FOR DAVE & ALISON LEWIS

During the recent trial of the Church Farm House arsonist the Judge praised the actions of Dave and Alison Lewis in fighting the fire and preventing its spread into the thatched roof before the emergency services arrived. His Honour Judge Kemp recommended that they should receive an award in recognition of their brave actions and this was presented on the 6th March 2012. In the picture Dave is flanked by the trial Judge and the High Sheriff.



The certificates presented to Dave and Alison read:

"This certificate was presented by the High Sheriff of East Sussex in recognition of an Order of the Crown Court made under Section 28 of the Criminal Law Act 1826 by His Honour Judge Charles Kemp whereby an award was granted from public funds to the person above named who showed great courage or performed other meritorious services leading to the apprehension and conviction of a criminal."

Our congratulations to Dave and Alison. Without doubt their speedy and brave actions prevented the house from suffering far more serious damage.

FLACKWELL ELECTRONICS — PURVEYORS OF PLASMA SCREENS TO THE GENTRY

FLACKWELL ELECTRONICS

OF CHURCH FARM, ASTON ABBOTTS

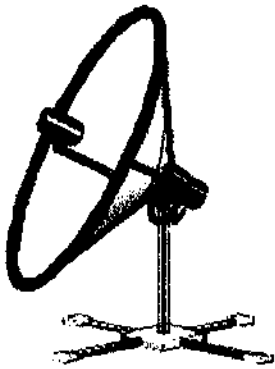

- **PLASMA**
- **LCD**
- **DVD**
- **HDTV**

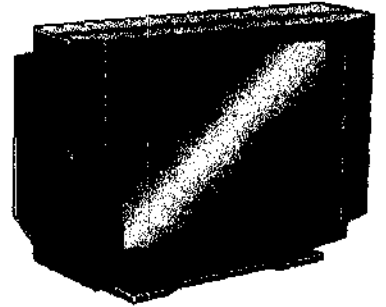

**RENTALS, NEW
AND USED SALES**

**01296
682126**



**01296
682126**

FLACKWELL

in association with

ELECTRONICS *Aston Autos*

A FREE CAR WITH EVERY TV SET*

Flackwell Electronics in conjunction with Aston Autos now offer the ultimate deal! Other dealers may offer a TV as a gift to tempt you to buy a car. But now Dave offers you the real deal - a free car with every TV*.

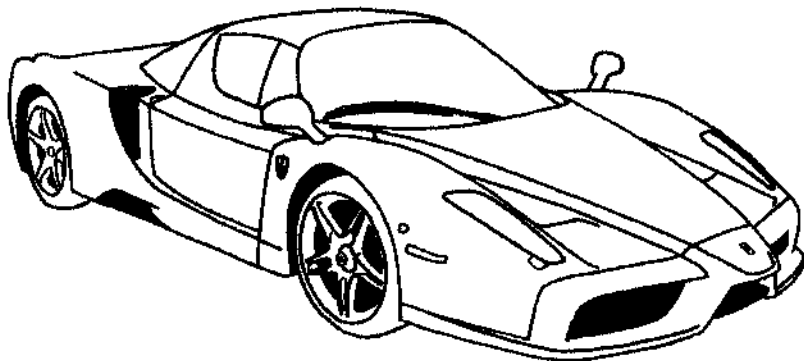

Yes, it's true, Dave is giving cars away these days. Grab yours before they are all gone.

**Aston Autos - never knowingly undersold
oversold sold!**

www.astonautos.co.uk

* Subject to availability. Terms, conditions and exclusions apply. Offer valid whilst stocks last. In the event of there being insufficient car stock to meet demand preference will be given to homeless vagrants. An on the road charge of £5,995 may apply. Aston Abbots residents are not eligible. By reading this you agree to vacate your house by noon on Saturday and hand over your keys and deeds. Offer not valid after 25.05.12.

FLACKWELL ELECTRONICS

OF CHURCH FARM, ASTON ABBOTTS

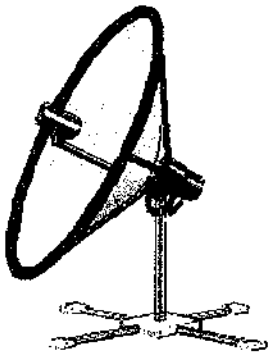

- **PLASMA**
- **LCD**
- **DVD**
- **HDTV**

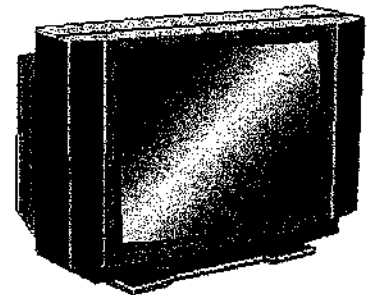

RENTALS, NEW
AND USED SALES

**01296
682126**



**01296
682126**

DAVE GOES FOR GOLD!

In a stunning development it was announced this week that Dave Lewis will be competing in the 2012 Olympics.

Dave's participation has been precipitated by his successful intervention in the Under-7's race at the Aston Abbots Jubilee Picnic. Dave invoked his Age Handicap, and joining the field half-way as the starting whistle blew he managed to beat every single one of the seven-year olds across the finishing line (just). Unfortunately he was subsequently disqualified for failing an alcohol test.

Nevertheless, inspired by this success, Dave applied to compete in the Olympic's 'Getting It Wrong With She-Who-Must-Be-Obeyed' event. However, upon receiving his application for that discipline the Olympic Committee immediately cancelled the whole event and sent Dave the Gold Medal in the post.

Undeterred, Dave has now decided to run in the 447 metre sprint. Those ignorant of Olympic events

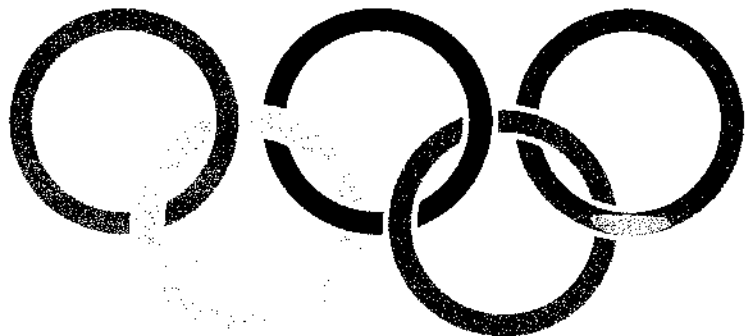

should realise that this is based upon the exact distance from Dave's workshop to the Royal Oak. As he is does this sprint very frequently he should do well, unless he once again succumbs to Friday Night Fever and pleads a lift off Graham Tomlin.

Incidentally Dave holds the unofficial world record for the return leg sprint from the Royal Oak to his workshop of 3 hours and 47 minutes (a time which includes the Hind's Hot-tub Handicap).

We wish you luck Dave - bring home the Gold!

FLACKWELL ELECTRONICS — PURVEYORS OF PLASMA SCREENS TO THE GENTRY

STRANGE MAN INVADES BALL

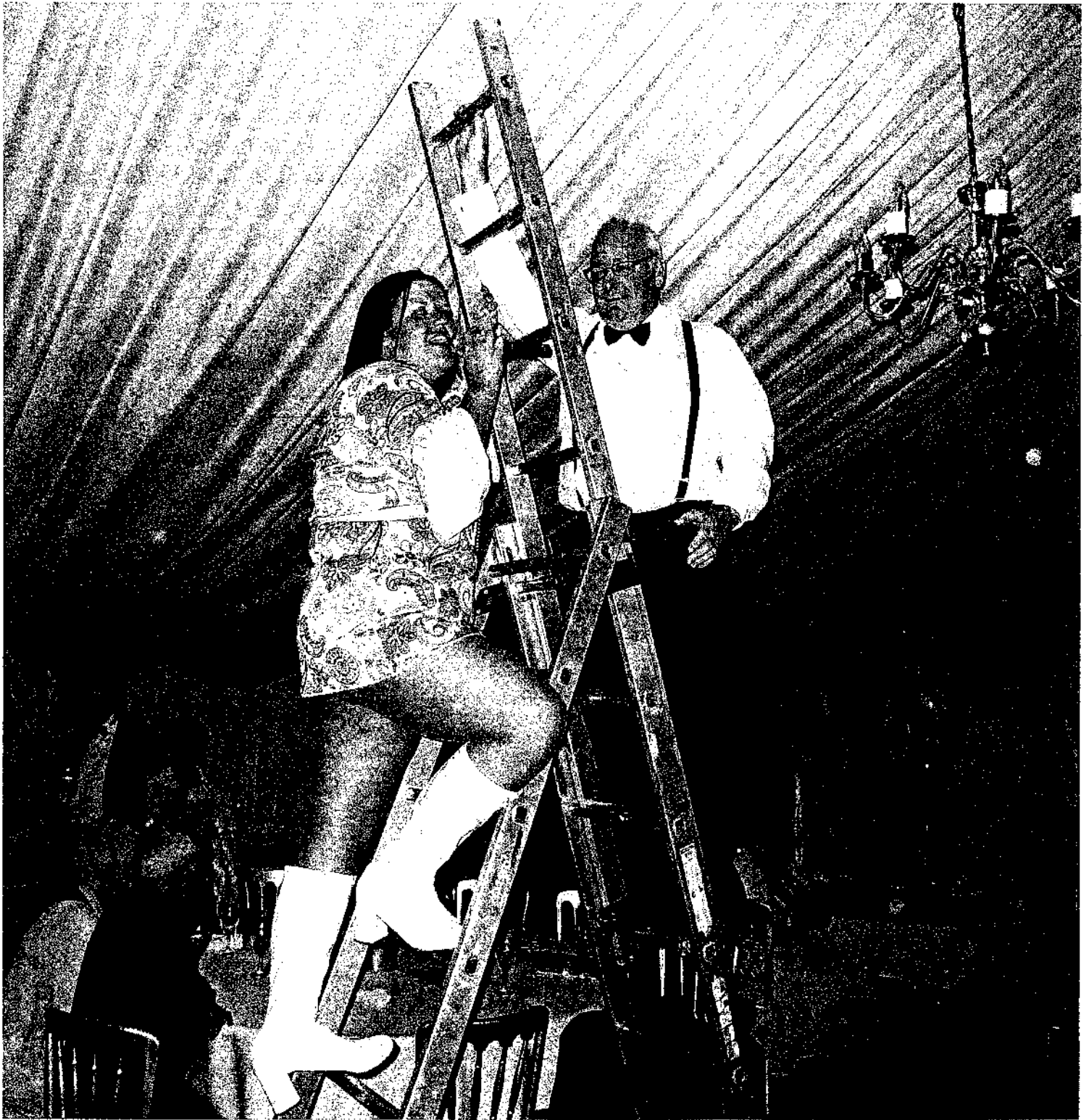

Revellers at Aston Abbotts' Summer Ball were left stunned by the wild antics of a strange man.

In a succession of bizarre incidents the man stood on tables making strange jerking motions, fenced off partygoers with a crutch stolen from a cripple, stood on a chair with his head in the tent roof, and leapt around wildly to Abba songs with a chair on his head.

Finally, aided and abetted by a tall Irishman, the maniac pursued a young lady wearing a very short skirt up a stepladder.

The man was not heard to utter one coherent word all night until, as he was dragged from the ball marquee in the early hours of the morning, he shrieked hysterically, "I've got an OBE y'know!"

FLACKWELL ELECTRONICS — PURVEYORS OF PLASMA SCREENS TO THE GENTRY

FLACKWELL ELECTRONICS

OF CHURCH FARM, ASTON ABBOTTS

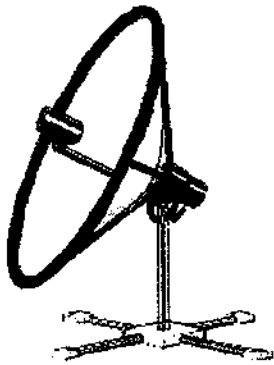

- **PLASMA**
- **LCD**
- **DVD**
- **HDTV**

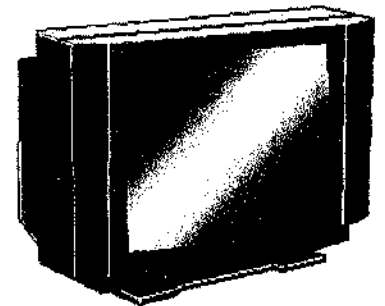

RENTALS, NEW
AND USED SALES

**01296
682126**

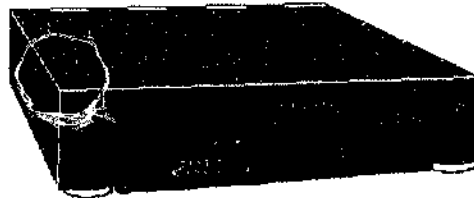

**01296
682126**

Ain't That The Truth !

- ◆ Light travels faster than sound. This is why some people appear bright until you hear them speak.
- ◆ We never really grow up, we only learn how to act in public.
- ◆ Knowledge is knowing a tomato is a fruit; Wisdom is not putting it in a fruit salad.
- ◆ Do not argue with an idiot. He will drag you down to his level and beat you with experience.
- ◆ Going to church doesn't make you a Christian any more than standing in a garage makes you a car.
- ◆ Better to remain silent and be thought a fool, than to speak and remove all doubt.
- ◆ The shinbone is a device for finding furniture in a dark room.
- ◆ God must love stupid people. He made SO many.
- ◆ A clear conscience is usually the sign of a bad memory.
- ◆ Artificial intelligence is no match for natural stupidity.
- ◆ Worrying works! 90% of the things I worry about never happen.
- ◆ Some cause happiness wherever they go. Others whenever they go.
- ◆ A bargain is something you don't need at a price you can't resist.
- ◆ If 666 is considered evil, is 25.8069 the root of all evil?
- ◆ Whoever coined the phrase "Quiet as a mouse" has never stepped on one.

A Message To All 630 Club Member's Wives

If your man promises to do something, it means that he'll do it. There is no need to remind him every six months!



FLACKWELL ELECTRONICS — PURVEYORS OF PLASMA SCREENS TO THE GENTRY

Dave Lewis

Flackwell Electronics

Church Farm

Cublington Road, Aston Abbotts, Aylesbury, Buckinghamshire

HP22 4NB

Phone 01296 682126

Fax 08713141439

Mobile 07910253970

Do you recognise this man?



He was :

- a former editor of the Chronicle.
- a sound engineer at Astonbury.
- often involved with village events.
- He has now moved on to bigger and better things.

After a brief holiday in the Channel Islands he embarked on a Body Building Course. This is the result!!

Ladies if you want to feel his muscles and lumpy bits for yourselves, call into the Royal Oak on Friday evenings. Carol is so pleased!

He can easily be spotted as he is now the bodyguard for local celebrity **Terry Daniels**.

Author of the Blockbuster new book, '**Passport to Hell**'.

Available from Amazon Released in January 2013 By Summersdale

FLACKWELL ELECTRONICS

DAVE AND ALISON WISH ALL
 OF THEIR FRIENDS IN ASTON
 ABBOTTS A VERY
 MERRY CHRISTMAS
 AND A
 HAPPY NEW YEAR



DAVE DENIES REHAB RUMOUR

Dave Lewis has been forced to deny rumours that he has gone into rehab after many people have spotted a gloomy Dave using Coke in the Royal Oak.

It has been widely known for some time that Dave has been doing Slime - a lethal cocktail of Lager and Lime - in large quantities. Recently, those close to him had also observed him taking large doses of Baileys, sometimes laced with caffeine.

Dave has insisted that he does not have a Slime habit, claiming that changing to the supposedly much safer Coke is simply an attempt to reduce his weight. However, those closest to him insist that he needs careful support during his cold turkey.

Dave's struggle with Slime abuse has clearly affected his demeanour. It is also having an effect on others, with one well-known local author claiming that it's now boring not being chased behind the bar on a Friday night.

ramazon

"Skeg 'eear lad, is dis slime?" I couldn't speak of word of Yorkshire, but I recognised the word "Slime" and I knew that I was in a lot of trouble.

At just 23 years old Dave Lewis was wrongfully accused of smuggling one million pints of Slime into Humberside. Read Dave's incredible true story in his amazing new book 'Pisspot to Hull' - available on January 7th via ramazon.

Retail price £9.99
 Our price £0.01p
 You save 99.9%
 ISBN: 184953344X



ASTON AUTOS—PURVEYORS OF FINE AUTOMOBILES AT BELOW COST PRICE

FLACKWELL ELECTRONICS

OF CHURCH FARM, ASTON ABBOTTS

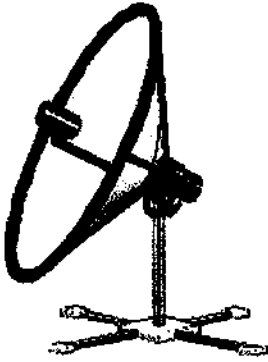

- **PLASMA**
- **LCD**
- **DVD**
- **HDTV**

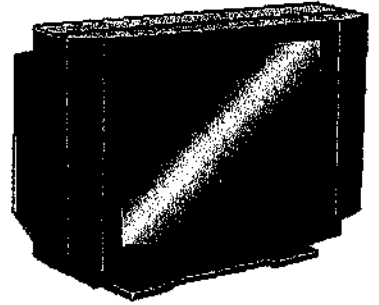

RENTALS, NEW AND USED SALES

**01296
682126**



**01296
682126**

CABERET



**LADIES AND GENTLEMEN,
BOYS AND GIRLS...
ROLL UP! ROLL UP! ROLL UP!!!
ON SATURDAY FEBRUARY 23RD**

**MR DAVID W LEWIS
WILL ATTEMPT, FOR THE VERY FIRST TIME, TO SAW
LOCAL AUTHOR MS TERRY DANIELS
IN HALF... USING A PETROL DRIVEN CHAINSAW...
...WHILST BLINDFOLDED!
DO NOT MISS IT! ONE PERFORMANCE ONLY!**

Terms and Conditions: Admission by pre-booked ticket only. Absolutely no refunds. Ms Daniels will be doing book signings before the performance only. The wearing of ear defenders by patrons is strongly advised. If Mr Lewis fails to complete the stunt successfully then a member of the audience will be chosen at random for the second attempt. Sponsored by RGC, Flackwell Productions Ltd of Church Farm accept no liability for accidental dismemberment of patrons.

FLACKWELL ELECTRONICS — PURVEYORS OF PLASMA SCREENS TO THE GENTRY

FLACKWELL ELECTRONICS

OF CHURCH FARM, ASTON ABBOTTS

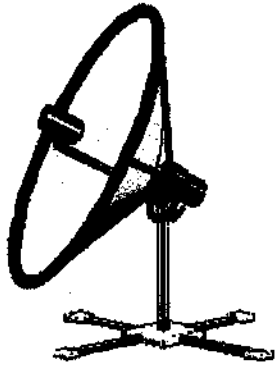

- **PLASMA**
- **LCD**
- **DVD**
- **HDTV**

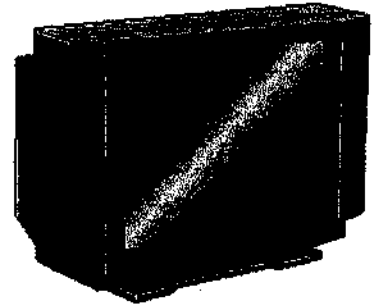

RENTALS, NEW AND USED SALES

**01296
682126**



**01296
682126**

DAVE'S CHAMPAGNE DIET!

It was a done deal! As soon as Dave read about the Champagne Diet (it's really true folks!) in The Daily Mail he decided that it was time to lose a few pounds. We have seen Dave turn into an obsessive-compulsive dieter, but what do other people think about dieting ???

My doctor told me to stop having intimate dinners for four. Unless there are three other people. - *Orson Welles*

Obesity is a condition which proves that the Lord does not help those who help themselves... and help themselves... and help themselves...

No diet will remove all the fat from your body because the brain is entirely fat. Without a brain, you might look good, but all you could do is run for public office. - *George Bernard Shaw*

A diet is when you have to go to some length to change your width.

Diets are for people who are thick and tired of it.

Dieting is not a piece of cake.

The toughest part of a diet isn't watching what you eat; it's watching what other people eat.

Sweets are the destiny that shapes our ends.

When you're on a diet, remind yourself that it's not the minutes spent at the table eating that put on weight, it's the seconds.

Food has replaced sex in my life; now I can't even get into my own pants.

She looked as if she had been poured into her clothes and had forgotten to say "when". - *P.G. Wodehouse*



BEFORE



AFTER

FLACKWELL ELECTRONICS — PURVEYORS OF PLASMA SCREENS TO THE GENTRY

FLACKWELL ELECTRONICS

OF CHURCH FARM, ASTON ABBOTTS

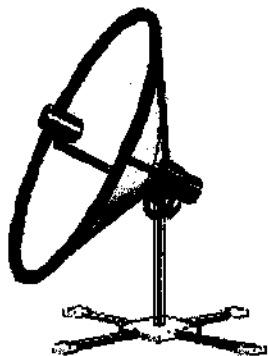

- **PLASMA**
- **LCD**
- **DVD**
- **HDTV**

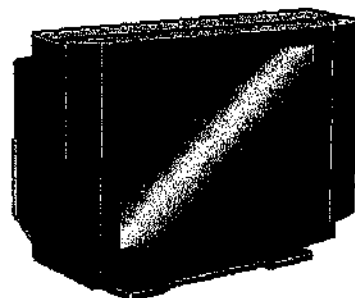

RENTALS, NEW AND USED SALES

**01296
682126**



**01296
682126**

DAVE DOES IT!

Yes - it really happened! in a stunning bit of theatre, the like of which hasn't been seen since Tommy Cooper played Macbeth, our very own Dave Lewis actually sawed a woman in half.

The amazing feat took place at the Aston Abbots cabaret in late February and was witnessed by the Irish Jesus, important local dignitaries, and John Whyte.

After being spurned by his selected victim guest Dave chose a member of the audience at random, selecting a 7 foot 6 inch tall beautiful woman who reluctantly stepped in to fill the coffin.

Those of you who could not be present upon this momentous occasion can experience the sheer horror of the moment on YouTube at http://youtu.be/ldUbt_U9gpM

At the time of going to press Mr Lewis refused to comment upon rumours that at next year's cabaret he will attempt to emulate David Copperfield's famous stunt by sawing himself in two.



FOR SALE

Flackwell Electronics have the following surplus items available for immediate sale :

- One large black plywood coffin, comes conveniently separated into two halves for easy transportation.
- One petrol chainsaw - good condition but a poor starter
- One plastic sack of assorted body parts

MISSING PERSON PLEA

Mr K Copping is seeking information regarding the whereabouts of his wife. She was last seen on the night of the Aston Abbots Cabaret. He told The Chronicle that it is, "very quiet without her".

FLACKWELL ELECTRONICS — PURVEYORS OF PLASMA SCREENS TO THE GENTRY

Flackwell Electronics

Flat panel TV servicing

Agents for Humax Digibox

Website = www.flackwellelectronics.co.uk

Phone 01296 682126

Established over a quarter of a century

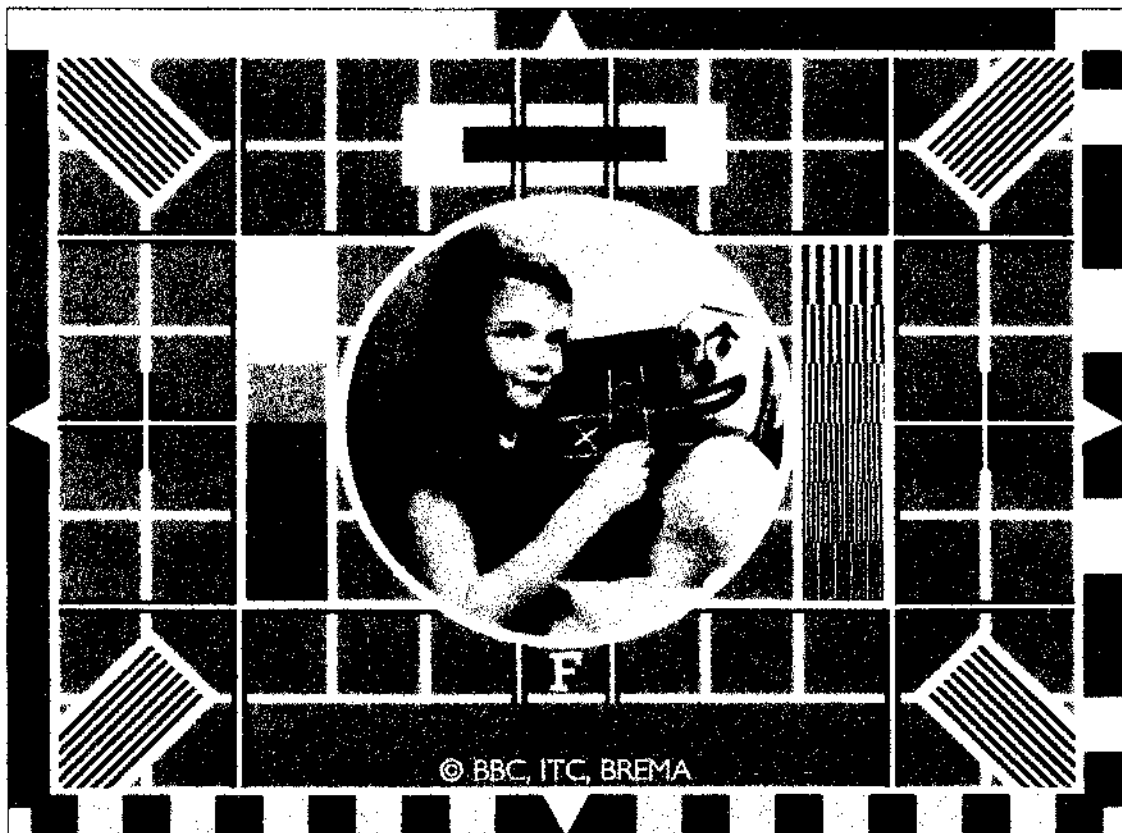

Purveyors of Plasma Screens to the gentry

FLACKWELL ELECTRONICS

OF CHURCH FARM, ASTON ABBOTTS

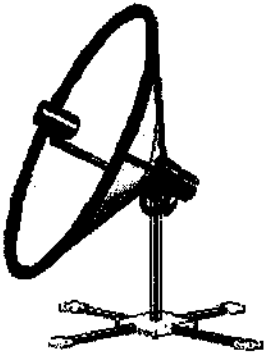

- **PLASMA**
- **LCD**
- **DVD**
- **HDTV**

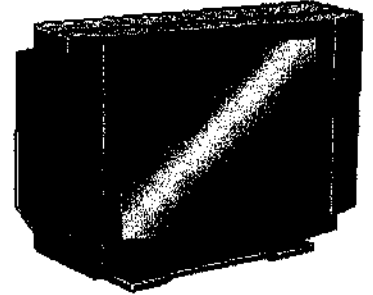

RENTALS, NEW AND USED SALES

**01296
682126**



**01296
682126**

DAVID'S DRY CLEANERS

We are proud to announce the launch of our new Dry Cleaning business.

Our operative is fully skilled in getting the most hideous stains out of your fabrics. Be sure to ask Dave about his recent cleaning experience.

SPECIAL OFFER

If you don't have any dirty fabrics with which to try out our services, just call us and we'll send Dave around to mess some up for you (an additional red wine charge applies).

DUVET GUARANTEE

We offer an unbeatable duvet cleaning guarantee—if we can't clean it, we'll burn it!!!



FLACKWELL ELECTRONICS — PURVEYORS OF PLASMA SCREENS TO THE GENTRY

Flackwell Electronics of Church Farm



Flat Screen LCD & Plasma Repairs

DVD & HDD Recorders

Supplied or repaired

Call 01296 682126

Purveyors of Plasma Screens to the Gentry

FLACKWELL INTERNATIONAL

CHURCH FARM—ASTON ABBOTTS

Dave Lewis is pleased to announce the world-wide expansion of Flackwell Electronics. Recently Dave has been opening branches all over the world. So far in 2013 he has personally opened branches in :

- ▶ Australia
- ▶ Portugal
- ▶ France
- ▶ The Isle of Wight
- ▶ Egypt
- ▶ Greece
- ▶ Cornwall

... and no doubt there's more to come!!!

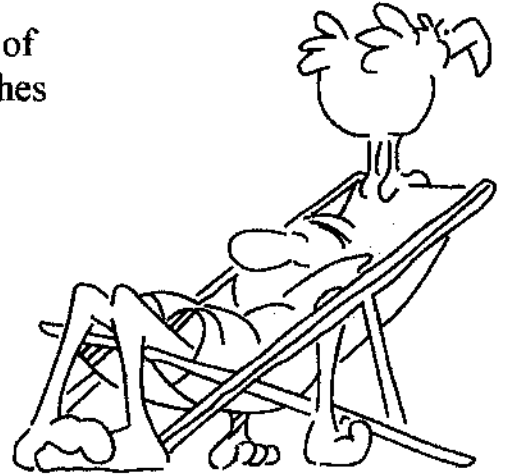

**+44 (0)1296
682126**



**+44 (0)1296
682126**

...and what about the Weather ????

Everyone talks about the weather, but no one does anything about it. ~ *Mark Twain*

The storm starts, when the drops start dropping. When the drops stop dropping then the storm starts stopping. ~ *Dr. Seuss*

When all is said and done, the weather and love are the two elements about which one can never be sure.

~ *Alice Hoffman*

But who wants to be foretold the weather? It is bad enough when it comes, without our having the misery of knowing about it beforehand. ~ *Jerome K. Jerome, Three Men in a Boat*

It always rains on tents. Rainstorms will travel thousands of miles, against prevailing winds for the opportunity to rain on a tent. ~ *Dave Barry*

It was one of those perfect English autumnal days which occur more frequently in memory than in life.

~ *P.D. James, A Taste For Death*

He cursed himself for having assumed the weather would be sunny. Perhaps it was

the result of evolution, he thought—some adaptive gene that allowed the English to go on making blithe outdoor plans in the face of almost certain rain. ~ *Helen Simonson, Major Pettigrew's Last Stand*

After three days men grow weary, of a wench, a guest, and weather rainy. ~ *Benjamin Franklin*

There is no way that we can predict the weather six months ahead beyond giving the seasonal average ~ *Stephen Hawking, Black Holes and Baby Universes*

Climate is what we expect, weather is what we get. ~ *Mark Twain*

I don't know if there is actually more rain here in England, or if it was just that the rain seemed to be so deliberately annoying. Every drop hit the window with a peevish Am I bothering you? Does this make you cold and wet? Oh, sorry.

~ *Maureen Johnson, The Madness Underneath*

I have discovered that the world over, unusual weather prevails at all times of the year. ~ *Edgar Rice Burroughs*

The days draw out, the weather gets warmer, and it's what we call summer, with a bitter laugh when we've said it. ~ *Stan Barstow, A Kind of Loving*

The weather is like the government, always in the wrong. ~ *Jerome K Jerome*

Would you bet your paycheck on a weather forecast for tomorrow? If not, then why should this country bet billions on global warming predictions that have even less foundation? ~ *Thomas Sowell*

Weather means more when you have a garden. There's nothing like listening to a shower and thinking how it is soaking in around your green beans. ~ *Marcelene Cox*

There are two seasons in Scotland: June and Winter. ~ *Billy Connolly*

You can have money piled to the ceiling but the size of your funeral is still going to depend on the weather. ~ *Chuck Tanner*

Weather is uncontrollable. Only the Lord above can control the weather. Whatever we get, we have to work with. ~ *Maurice Greene*

FLACKWELL ELECTRONICS — PURVEYORS OF PLASMA SCREENS TO THE GENTRY

FLACKWELL ELECTRONICS

OF CHURCH FARM, ASTON ABBOTTS

01296 682126

Dave to be MP ?



The Daily Mail reported on August 13th that Buckingham MP John Bercow will step down in 2016, and prospective Tory leader Boris Johnson will be shoe-horned into our safe Buckingham seat.

Here at The Chronicle we are privy to a further secret. **BORIS JOHNSON AND DAVE LEWIS ARE THE SAME PERSON!** Here we present the evidence. First, lets look at what Boris/Dave says.

Boris on Tony Blair: *"It is just flipping unbelievable. He is a mixture of Harry Houdini and a greased piglet. He is barely human in his elusiveness. Nailing Blair is like trying to pin jelly to a wall."* Is that Boris speaking... or does it sound like Dave?

Boris Johnson on Channel 5: *"I don't see why people are so snooty about Channel 5. It has some respectable documentaries about the Second World War. It also devotes considerable airtime to investigations into lap-dancing, and other related and vital subjects"*. Is that Boris speaking... surely it sounds like Dave?

Boris Johnson on UKIP: *"I can hardly*

condemn UKIP as a bunch of boss-eyed, foam-flecked Euro hysterics, when I have been sometimes not far short of boss-eyed, foam-flecked hysteria myself." Is that Boris speaking... No, that has got to be Dave!

Boris Johnson on how to vote: *"Voting Tory will cause your wife to have bigger breasts and increase your chances of owning a BMW M3."* Is that Boris speaking... No - obviously that is Dave!

Boris on Liberal Democrats: *"The Lib Dems are not just empty. They are a void within a vacuum surrounded by a vast munition."* Is that really Boris speaking... or is it just Dave armed with a dictionary?

Now the photographic evidence. Look at the pictures of Boris and Dave below. Do you see the uncanny resemblance?

Finally, ask yourself this: have you ever seen Boris and Dave together in the same room at the same time? No? WE REST OUR CASE!

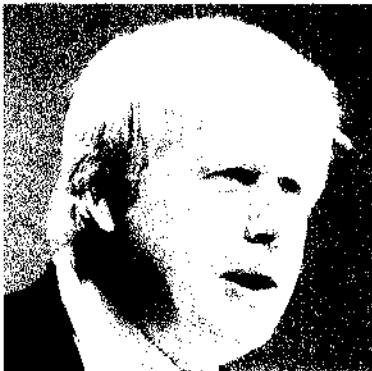

Boris Johnson



Dave Lewis

Tax Dodgy

Dear Sirs,

I wish to complain in the strongest possible terms about villagers spreading scurrilous rumours that Dave is attempting to spend more than six months out of the UK in 2013, just in order to avoid paying UK Income Tax.

This is untrue - everybody should pay taxes and we have always been pleased to make our contribution to the government.

If I catch anybody else spreading these rumours they will be fined £25 with a £10 victim surcharge - and they will be given three points on their driving license.

Yours angrily,

Name and occasional UK address supplied, c/o Paraiso Fiscal Praia, Portugal

Editor's Note:

The John Bercow story and the Boris Johnson quotes have been sourced from the Daily Mail website - so they must be true!

FLACKWELL ELECTRONICS — PURVEYORS OF PLASMA SCREENS TO THE GENTRY

e sent as a single picture which is just dropped onto the page here

FLACKWELL ELECTRONICS

OF CHURCH FARM, ASTON ABBOTTS

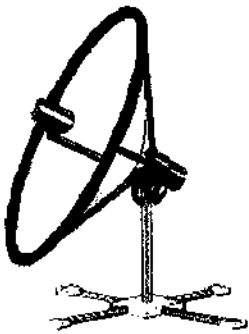

- **PLASMA**
- **LCD**
- **DVD**
- **HDTV**

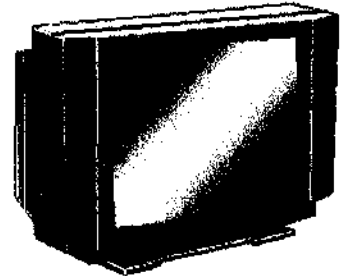

AVIATION HEADSET REPAIR

**01296
682126**

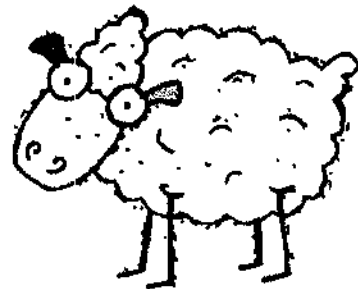
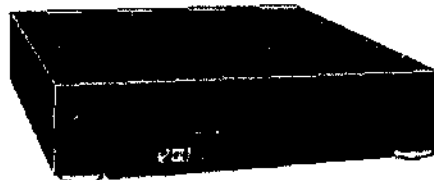

Dave Lewis is Welsh !!

Startling news from the recent gathering of Aston Abbots tax exiles in Portugal.

It has been discovered that Dave Lewis is actually Welsh! That astonishing revelation means that Neil Cheshier is no longer the only ga.... errr.... Welshman in the village!

I went to Cardiff last week and had a run in with the Taffia, the welsh contingent of the Mafia; They made me an offer I couldn't understand...

What do you call a Welshman with a stick up his backside? A Taffy apple!

A married couple are on holiday in Wales, and they stop for lunch at the famous town of Llanfairpwllgwyngyllgogerychwyrndrobwillantysiliogogoch.

The husband calls over the waitress and asks, "I was wondering if you could settle an argument, how exactly do you pronounce the name of this place?"

The waitress looks at him and says, "Burger King."

How does a Welshman find sheep in long grass? Irresistible!



FAMOUS WELSH FILM TITLES

- 9 1/2 Leeks
- The Lost Boyos
- Huw Dares Gwyneth
- Dai Hard
- The Wizard of Oswestry
- Cool Hand Look-you
- Sheepless in Seattle
- The Eagle has Llandudno
- The Magnificent Severn
- Haverfordwest Was Won
- Austin Powys
- The Magic Rhonddabout
- The Bridge on the River Wye
- A Beautiful Mind-you
- Breakfast at Taffynys
- Look Back in Bangor
- Evans Can Wait
- A Fishguard Called Rhondda
- Where Eagles Aberdare

FLACKWELL ELECTRONICS — PURVEYORS OF PLASMA SCREENS TO THE GENTRY

FLACKWELL ELECTRONICS

OF CHURCH FARM, ASTON ABBOTTS



- PLASMA
- LCD
- DVD
- HDTV



**AVIATION
HEADSET
REPAIR**

01296 681544

Alison and Dave

wish all of their friends in

Aston Abbots a very

Merry Christmas

and a

Happy New Year

FLACKWELL ELECTRONICS — PURVEYORS OF PLASMA SCREENS TO THE GENTRY

FLACKWELL ELECTRONICS

AVIONICS SPECIALISTS
Prop. David Lewis
(Established 60 years)

New Phone number:
0960 60 60 60

Calls charged at £60 per 60 seconds, or use
01296 682126 for local call rates

ASTON ABBOTTS

WATCHOWER

New Aston Abbots Home Opens

The Aston Abbots Home For Homeless Young Men is now open at Church Farm and is already proving extremely popular. Please contact Dave Lewis if you are seeking a place. Free bacon sandwiches and extremely low rental rates for all successful applicants.

John Whyte has a Leak

We have to report that Mr Whyte had a leak on Dec 23rd. This leak was on his kitchen roof and is different to the one that he had in the hedge on his way home from The Royal Oak on Christmas Day. A Stewkley builder and an Irishman attempted to remedy both situations, with only partial success.

Exam Failure

We are sad to report Mr David Lewis' failure in his Ground School flying exam. He got one question wrong and consequently only managed to score 96 out of a possible 100.

Christmas Disappointment

Some will have been delighted with their Christmas surprises, but others may have been left feeling a little let down. None so let down as one-time Chronicle editor Phil Spooner, who was initially excited when his wife suggested he visit Pussy Palace in Weston Turville. However, we understand their cat Lila had a great Christmas holiday there. (*More info at www.rabbitritz.co.uk/pussy-palace.htm*)

Mr and Mrs Whyte Do Not Drink—Official!

That was the shock announcement made by John Whyte at Christmas. John chose to make the revelation about their long-term abstinence in The Royal Oak on Christmas morning. Now that he and Deirdre have finally come out as the teetotallers they apparently are it is expected that they will be inviting their friends to join their Aston Abbots Abstinence Society. Any takers? No... I thought not...

Ask Auntie Fran

Please send your questions to Aston Abbots' own agony aunt Auntie Fran, c/o The Chronicle

Dear Auntie Fran,

I am at a loss as to what to do about my husband? Usually he is completely outrageous, but he has been very well-behaved all over Christmas. I am very worried about this sudden change. Do you think he needs help? Please advise me—I'm desperate!!! ~ A.L., Aston Abbots.

Dear A.L.,

This happens to many men when they reach a certain time in life, and especially as a BIG birthday approaches. I am sure that when he passes this psychological hurdle his normal behaviour will return. Hug him, love him, and be patient with him. ~ Auntie Fran

Position Offered

A vacancy has arisen for an assistant to work alongside Mr Dave Lewis. Please contact the Company Secretary. She says that the successful applicant will need to be blind, deaf and have no sense of smell!

FLACKWELL ELECTRONICS — PURVEYORS OF PLASMA SCREENS TO THE GENTRY

FLACKWELL ELECTRONICS

AVIONICS SPECIALISTS

**Prop. David Lewis
(Established 60 years)**

**We also repair TV, DVD and
electrical appliances**

01296 682126

www.flackwellelectronics.co.uk

ASTON ABBOTTS

WATCHOWER

Vegetable Abuse Enquiry Call

Calls have been made for a full public enquiry into suspected vegetable abuse in Aston Abbotts following last months revelation that a village elder has taken to secreting vegetables in his bedroom (The Chronicle, January 2014).

In the meantime, should you see a parish councillor wearing red trousers and cavorting with a courgette, please inform the police immediately.

Much A-Poo About Nothing

The controversy surrounding the manure heap that the allotmenters left in The Orchard has now reached the local newspaper. However we must challenge Mr Simon Guy's assertion in the January 22nd Bucks Herald where he states, "It's not an EU regulation".

Villagers who have observed the EU over many years may well have reached the conclusion that the European Union and horse manure do indeed go hand in hand. Therefore, it is safe to assume that there IS an EU directive covering dung.

Consequently, we are concerned that the pile may not be legal. Having carefully studied Mr Guy's pile of poo at close quarters we see no evidence of the mandatory CE mark that indicates compliance with the relevant EU directives regarding the consistency and size of the droppings.

In short, villagers need to be assured that Mr Guy's poo is up to standard.



More Sex (togenerians)

Hot on the heels of last months sneaky revelation that Dave Lewis has turned 60 comes news of another sextogenerian in Aston Abbotts. Unfortunately, the Chronicle editor - Phil 6Orrigan - has explicitly forbidden me from revealing the identity of the poor unfortunate soul.

Lost and Found

Found in the recreation ground after the Christmas festivities:

- 18 beer cans
- A bobble hat
- A pair of knickers

The first item has been recycled, the other two may be reclaimed from Richard Clarke.

Beautiful Gift

Celebrate Aston Abbotts' famous pile of poo with an exquisite commemorative set of six table mats with six matching drinks coasters, each featuring a full colour picture of the steaming manure heap in the Orchard.

No need to pay, or even to place an order! Just wait, and the allotmenters will come round and leave them in your front garden when you're not looking.



FLACKWELL ELECTRONICS — PURVEYORS OF PLASMA SCREENS TO THE GENTRY

FLACKWELL ELECTRONICS

AVIONICS SPECIALISTS
Prop. David Lewis
(Established 60 years)

**We also repair TV, DVD and
electrical appliances**
01296 682126
www.flackwellelectronics.co.uk

ASTON ABBOTTS

WATCHOWER

The Obelisk

Villagers may have noticed groups of disappointed looking tourists cruising the village in recent weeks. Bussed out from Aylesbury to view the famous Aston Abbots manure heap, they were bitterly disappointed to find that our Glorious Leader had single-handedly removed most of the heap onto his own allotment.

However, had they cast their gaze down to the far end of The Orchard they would have noticed a new wonder in Aston Abbots: The Obelisk.

This new attraction is apparently the original Trig Point that was located upon Lines Hill. Made redundant by modern mapping techniques, it has long since been abandoned. Now this block of concrete has been rescued and lays resting drunkenly at the far end of The Orchard.

But it is not its sudden appearance that concerns me - it is the fact that it is apparently named "Trevor".

Now, I don't want to point fingers at people who name inanimate objects. Each to his own. After all, I once knew a man who collected pillar boxes and filled his garden with them. But I'm quite confident that never in all of Marcus's wildest and most short-sightedly befuddled deodorant-free days did he ever actually *name* any of his red cast-iron extended family!

But I digress. It is not actually the naming that concerns me. What deeply troubles me is... how did they know that it was male?

All I can say is that if the sexing of that half-ton of whitewashed inanimate concrete is accurate, then I find myself once again in complete and utter awe of Peter Knight's husbandry skills!

Police Seek Miscreant

Police have appealed for information after a desperate chase to catch a man who vaulted over the entrance barrier at the Marylebone station toilets in order to avoid paying the 30p charge.

Police described the man as being middle-aged, with short grey hair, looking like he had recently lost weight, and carrying a television engineer's repair box. They followed the man to Aston Abbots but lost him around the area of The Old Masters.

If anybody has any information about this man, please contact the local constabulary.

Safety Advice

If you must use FaceTime or Skype on your iPad then please make sure you switch on the camera that *faces* you and *not* the rear-facing camera. Otherwise you might just transmit pictures of your wife in 'an unfortunate pose' half way around the world.

An Apology

We wish to apologise for the recent good behaviour of Mr David W Lewis. This is due to circumstances outside of our control.

We understand that he is now being treated with a mixture of champagne and codeine and we remain hopeful that a relapse will occur soon.

FLACKWELL ELECTRONICS — PURVEYORS OF PLASMA SCREENS TO THE GENTRY

FLACKWELL ELECTRONICS

AVIONICS SPECIALISTS
Prop. David Lewis
(Established 60 years)

**We also repair TV, DVD and
electrical appliances**
01296 682126
www.flackwellelectronics.co.uk

ASTON ABBOTTS

WATCHTOWER

Hot Stuff

Congratulations to The Lissan restaurant at The Carpenters Arms in Stewkley. After several previous attempts they finally managed to defeat Dave Lewis.

Dave ordered his usual vegetable thaal "as hot as you can make it". When it arrived he took a big mouthful. There was a sudden silence. "That's hot!" gasped Dave, his eyes squinting. Within 30 seconds he had gone bright red. Grabbing his lager and lime he swallowed deeply. Manfully, he took another few mouthfuls. Sweat beaded on his forehead and he started coughing uncontrollably. Determined not to be beaten he stuffed half a Naan bread into his mouth.

Then in a fit a bravado he took yet another mouthful of the thaal. His face froze, a tear appeared in his eye, and he put down his spoon. The defeat was total, and it became apparent that Dave Lewis was no longer capable of speech.

Winner: The Lissan Restaurant, Stewkley

STOP PRESS - Is the Bypass Back?

Longer-term residents will remember that around the time the Bull and Butcher was sold a rumour went around that there was to be an Aston Abbots "bypass" - a road running up just East of the village 100 yards behind the Royal Oak and The Bull and Butcher. Everybody was very worried about developers trying to build infill between the new road and the existing houses.

Well, there are rumours that the idea is back and apparently the Council have seen a proposal. This could become a hot topic at the forthcoming Annual Parish Meeting. Obviously this is nowhere near a formal application stage, but we found a very brief overview of the developer's concept on the Council website at www.tinyurl.com/aabypass

What's In A Name?

After last month's back page rant about the naming of inanimate objects I was aghast to read in the same issue that Mr Phillips had named his shed 'Nathan'. What is going on? A Trig Point named 'Trevor'. A shed named Nathan. Whatever next in Aston Abbots? A church named Charlotte? Nooooo... please!

I am reminded that when I bought my first brand new car (a Mk1 Fiesta XR2, if you must know) I announced proudly on its maiden voyage that I thought I might call it 'Katie'. My wife immediately demanded to know why I had chosen a female name, the brittle icy edge to her voice conveying the certainty that I had just dug myself a hole from which there was little chance of escape.

This leads me to ponder the effect on Mr Phillips' domestic happiness should he have been less careful and not named his shed 'Nathan', but 'Natalie'? In my experience an innocent sunny Sunday afternoon's allotmenting being announced as, 'I am just popping down to Natalie for a while' could cause irreparable relationship damage! It's a dangerous world out there! Be careful chaps.

How Observant Are You?

Hands up! Who failed to spot that I misspelt 'Watchtower' the last 3 months. Come on, my wife's not the only one, surely???

FLACKWELL ELECTRONICS — PURVEYORS OF PLASMA SCREENS TO THE GENTRY

FLACKWELL ELECTRONICS

AVIONICS SPECIALISTS
Prop. David Lewis
(Established 60 years)

We also repair TV, DVD and electrical appliances
01296 682126
www.flackwellelectronics.co.uk

ASTON ABBOTTS

WATCHTOWER

Miscreant Flees Overseas?

An incident in Hong Kong airport has led to fears that the miscreant who vaulted over the barrier at Euston station toilets (see The Chronicle, March 2014) has now fled abroad. Although at the time the man was traced to the Church Farm area of Aston Abbots, Hong Kong airport police now say that a man matching the villain's description recently broke into a Perspex toilet roll holder in their airport. They say they have no clue as to the reason for the man's action, but they believe him to be desperate.

A half-day later Australian police say someone they believe to be the same man was seen acting oddly in the immigration queue at Sydney airport. Police say he stood motionless for over an hour just staring forwards and downwards. They are anxious to trace the passenger ahead of him in the queue, who they have described a young skinny Goth girl, with multiple piercings, wearing a tiny, tight pair of shorts. A pool of saliva found on the floor where the man was standing has been removed for DNA analysis.

If anybody can throw light upon the identity of this man please contact The Chronicle and we will forward the information to the relevant international authorities.



Church Notice

Would gentlemen attending formal family occasions in the Church please ensure that their flies are done up.

This request applies particularly to former Chronicle editors, as well as to normal people.

Thank you.

Stuck!

A Welshman from Nash's Farm has informed The Chronicle that he became stuck in the Channel Tunnel for over two hours!

Several of his friends commented that given his rotundity they were not at all surprised.



FLACKWELL ELECTRONICS — PURVEYORS OF PLASMA SCREENS TO THE GENTRY

FLACKWELL ELECTRONICS

AVIONICS SPECIALISTS
Prop. David Lewis
(Established 60 years)

We also repair TV, DVD and electrical appliances
01296 682126
www.flackwellelectronics.co.uk

ASTON ABBOTTS

WATCHTOWER

Thunderbirds Are Go!

Dave Lewis has taken delivery of a brand-new lawnmower. His futuristic, sexy bright red machine is known as Thunderbird 6 and it has the widest lawnmower cut known to man.

Now we don't want to point any fingers, or cause any embarrassment. After all, everybody knows that Dave is Aston Abbotts' one-man International Rescue. However, we harbour a deep suspicion that before Scott Tracy pressed the button to launch Thunderbird 1 on its inaugural flight he would have a) measured the width of his rocket and b) measured the diameter of its launch exit.

Might we respectfully suggest to Dave that a similar exercise involving a tape measure might have avoided damage on Thunderbird 6's inaugural outing!

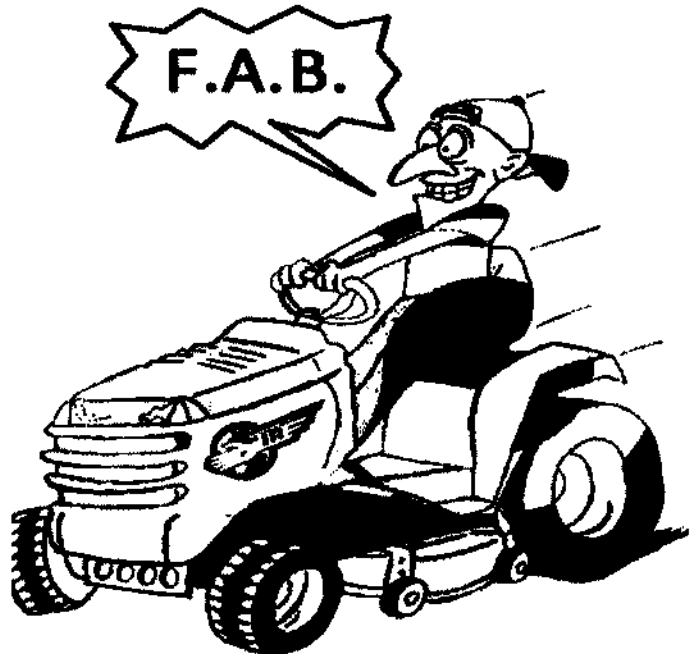

Toilet Fiend Strikes Again

Following previously reported toilet incidents in Euston and Hong Kong airport (see the Chronicle March, May 2014) the toilet fiend has struck again.

Police say that a respectable middle-aged mother attending her daughter's wedding was confronted by the same grey-haired man in the Ladies toilets during the reception. When other guests

discovered them the man allegedly made an outrageous remark that cast doubt upon the sanctity of the mother's marriage, then fled.

Police tracked the man, but lost him in the vicinity of The Royal Oak, Aston Abbotts at around 10pm last Friday. They have warned that the man has now attempted to disguise himself by losing weight.

Reunion

We understand that the terrorist has been back to Tenerife. Carefully avoiding the usual mundane trappings of her previous Spanish excursions -- hangovers, Spanish tummy, sunburn, getting banged up for ten years -- we hear that she attended a fancy dress party dressed in an orange prison uniform with the word "GUILTY" emblazoned across the back in large letters!

FLACKWELL ELECTRONICS — PURVEYORS OF PLASMA SCREENS TO THE GENTRY

FLACKWELL ELECTRONICS

AVIONICS SPECIALISTS
Prop. David Lewis
(Established 60 years)

We also repair TV, DVD and electrical appliances
01296 682126
www.flackwellelectronics.co.uk

ASTON ABBOTTS

WATCHTOWER

DARING RESCUE IN ASTON ABBOTTS !!

Tragedy in Aston Abbotts was narrowly averted when a member of the 630 Club became trapped in his own front porch.

The man could have been stuck in there for days, but by chance a passing Irishman heard the man's desperate cries for help and, after he had finished laughing, carried out a life-saving rescue.

We are unable to name the man for legal reasons, but we understand he is considering rewarding his rescuer by presenting him with a second-hand OBE.

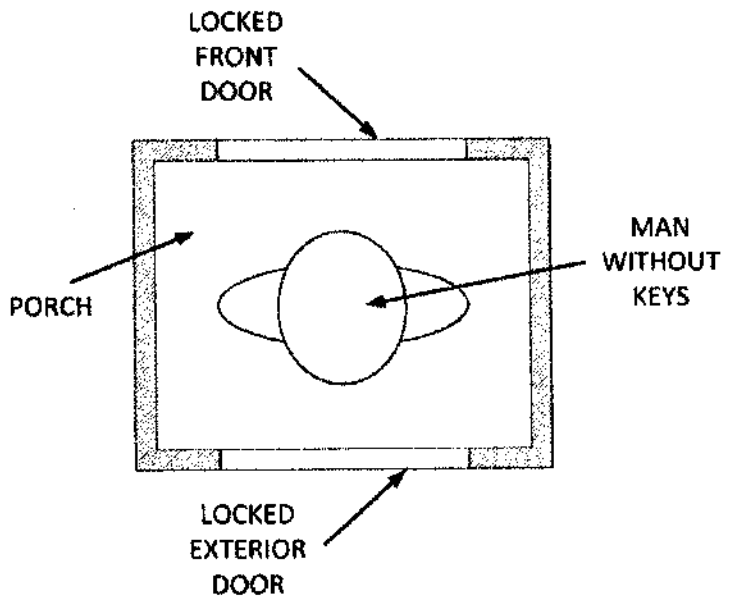

Deputy Prime Minister

We have been told that Chronicle editor Phil Corrigan recently attended a question and answer session with Nick Clegg, the deputy prime minister.

A number of difficult questions regarding UKIP and Nigel Farrage were posed, but unfortunately Mr Corrigan couldn't answer any of them!

Bad Decisions

On his instrument flying course Mr David Lewis apparently flew his plane straight down through an important marker called the 'decision height', not once, but twice!!! Those are very serious errors!

As a result of his furious reaction upon being told of his mistakes he was sent on an Anger Management Course, but he stormed out of it!

FLACKWELL ELECTRONICS — PURVEYORS OF PLASMA SCREENS TO THE GENTRY

FLACKWELL ELECTRONICS

AVIONICS SPECIALISTS
Prop. David Lewis
(Established 60 years)

We also repair TV, DVD and electrical appliances
01296 682126
www.flackwellelectronics.co.uk

ASTON ABBOTTS

WATCHTOWER HOT TIPS!



Aston Abbotts' own style guru, social advisor and agony aunt brings you some of her hottest tips for happy, healthy living

WEDDING ANNIVERSARY TIP

Guys! Wedding anniversaries are a reminder of the best day of your lives, so you do need to make a real effort to make her feel special on such an important day.

My tips for aviators to ensure they have a very happy wedding anniversary:

1. Do not forget your wedding anniversary
2. When you do forget your anniversary, sneak out to Wing and buy a card in the early morning hours
3. When you get back home, *do not* write "Happy Birthday" inside the card!

MARRIAGE PROPOSAL TIP

Everybody loves a wedding—and the village has been filled with excitement over the news of impending nuptials between two of our long-standing singles!

Here is my hottest tips for bachelor Chronicle editors making spurious marriage proposals to eligible village ladies:

1. Make sure she is so drunk that she does not remember
2. Make sure you are so drunk that you do not remember
3. Make sure your friends are so drunk so that they do not remember and tell The Chronicle about it!

WELSH CHUNKEE TIP

Great news!

Three of Aston Abbotts' famous singing group The Chunkees are to appear in Fiddler On The Roof in Tring.

At rehearsal one of the group started making strange jerking movements. Fearing that he was suffering a seizure the other Chunkees rushed to his aid, but he explained he was just doing *Nantgarw* - the Welsh national dance.

My top tips for dancing Welsh Chunkees:

1. Don't!
2. Please don't!
3. STOP IT !!!!

FLACKWELL ELECTRONICS — PURVEYORS OF PLASMA SCREENS TO THE GENTRY

FLACKWELL ELECTRONICS

AVIONICS SPECIALISTS
Prop. David Lewis
(Established 60 years)

We also repair TV, DVD and electrical appliances
01296 682126
www.flackwellelectronics.co.uk

I've accidentally swallowed some Scrabble tiles. My next visit to the loo could spell disaster.

What did the Mama Cow say to the baby cow? It's pasture bedtime...

Despite the risks to her health, my sister insists on drinking Diet Coke. I guess you could say she's a sodamasochist...

I went to a hypnotist yesterday - he convinced me I was the atomic number 82. I'm easily lead.

Have you heard about the evil group of men who control all the world's cheese? The hallouminati.

Bought the missus a hamster-skin coat last week. Took her to the fair last night, and it took me 3 hours to get her off the Ferris wheel.

A woman accompanied her husband when he went for his annual physical check-up. While the patient was getting dressed after the examination, the doctor came out of the examining room and said to the wife, "I don't like the way he looks." "Neither do I," she said. "But he's handy around the house."

I've been dating a TV weather girl as I thought it'd make a nice change to be with a woman that wasn't right all the time.

My daughter has just put the wife's sister in a hot-air balloon and quickly untied the tether. They're really upping the ante this time.

In 1997 if you asked a woman if you could Google her Wikipedia with your iPad, she would have slapped you.....

My favourite exercise is a cross

between a lunge and a crunch. It's called Lunch.

A young apprentice optometrist recently got careless and got his hand caught in the lens grinder. He wasn't seriously hurt...he just made a spectacle of himself.

My wife told me: 'Sex is better on holiday.' That wasn't a very nice postcard to receive.

Polygamy - the art of parrot-folding.

A man walked into B&Q and picked up a can of fly spray. "Is this good for wasps?" he asks the assistant. "No, it kills them" was the reply.

Chicken Teriyaki - The name of the oldest living Kamikaze pilot.

A female prisoner has told her guard that she will marry him if he helps her to escape. This is an example of using a proposition to end a sentence with.

Now I'm getting older my memory's not as sharp as it used to be. Also, my memory's not as sharp as it used to be.

An Engineer just started his own business in Afghanistan. He's making land mines that look like prayer mats. It's doing well. He says prophets are going through the roof.

I'm the kind of guy who stops the microwave at 1 second just to feel like a bomb disposal expert.

Dentists make money off of people with bad teeth. Why should I trust the toothpaste they recommend?

My vacuum cleaner broke, so I put a Tottenham Hotspurs sticker on it and now it sucks again.

Yawning is your bodies way of saying 20% battery remaining.

Don't you just hate it when someone answers their own questions? I do.

You know my father threw a camera at me once. I still have flashbacks.

I saw a guy on his motorcycle and the back of his shirt said "If you can read this the b*tch fell off."

One day while in a bank, an old lady asked if I could help her check her balance... so I pushed her over

I hate Circles, they're pointless

I'm friends with 25 letters in the alphabet. I don't know why.

There was a zoo that had one animal in it. That animal was a dog. It was a shitzu.

I used to live next to a farm and every time I passed the cows in the field I used to inexplicably shout abuse at them. Turns out I'm dairy intolerant.

This bloke said to me: 'I'm going to attack you with the neck of a guitar.' I said: 'Is that a fret?'

I thought Benefits Street was a budget box of chocolates that you could buy at Lidl.

Who remembers when X Factor was just Roman suncream?

Even the word misogyny is misogynistic. It should be ms-ogyny.

The only legitimate reason for smoking an electronic cigarette is if you are a robot that has just had sex with another robot.

My dad said: 'Always leave them wanting more.' Ironically, that's how he lost his job in disaster relief.

If I discovered a new animal I'd call it a Quorn just to mess with vegetarians. I don't believe in sceptics.

FLACKWELL ELECTRONICS — PURVEYORS OF PLASMA SCREENS TO THE GENTRY

FLACKWELL ELECTRONICS

AVIONICS SPECIALISTS
Prop. David Lewis
(Established 60 years)

We also repair TV, DVD and electrical appliances
01296 682126
www.flackwellelectronics.co.uk

ASTON ABBOTTS WATCHTOWER

Goodness Gracious...

...Great Balls of Fire!
Congratulations to Dave Lewis for cycling 58 miles for charity. However, we question his wisdom in buying a new bike just days before the event. After cycling for miles on the hard saddle of the gleaming new hybrid he was seen hobbling around the village with bowed legs and tears streaming down his face!

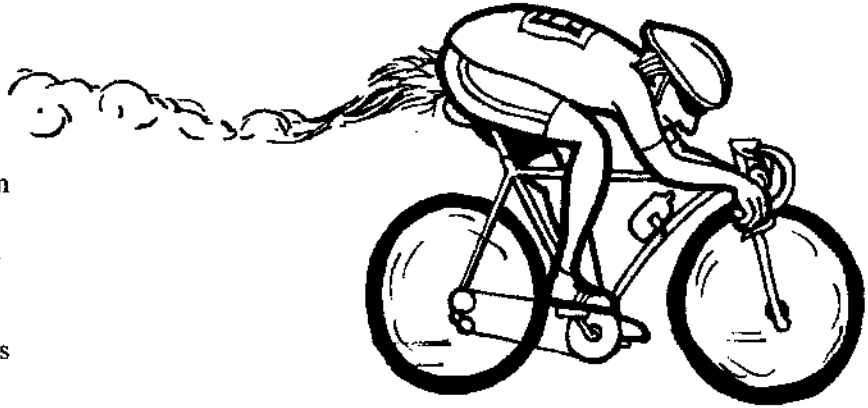

Is it a Bird? Is it a Plane?

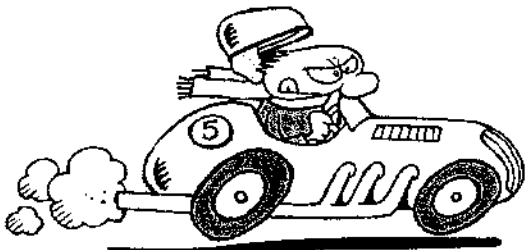

"He must have been doing over eighty when he entered the village!" "He was still doing sixty when he went round the corner by my house!"

Who were they talking about? Just a barely glimpsed streak of blue with loud cursing emanating from the sun roof. Who was it? We demand to know!

Fiddler on the Hoof

We hear that John Whyte has run off from the Tring production of Fiddler. His official reason is that he had too many golf engagements booked, but we suspect that he was actually rather jealous that he could not grow a beard as spectacular as Nigel Palmer's.

Moving On

Someone has contacted the Chronicle to ask if the 'House For Sale' sign that has appeared outside the house of a long-term single lady resident has any connection with the spurious marriage proposal mentioned on the Back Page two months ago? We would like to know too!



New Partner Sought

Dave Lewis has expressed disappointment that his Partner In Life failed to support and accompany him on his recent two visits to the cinema. The first day consisted of a series of presentations on The Art Of Gerry Anderson and the second was a back-to-back showing of five episodes of Thunderbirds.

Dave cannot understand how any girl can fail to be wowed by such wonderful outings and he would like to hear from any ladies who share his interests. He warns that there may be a delay in replying, as he works through the anticipated deluge of responses.

FLACKWELL ELECTRONICS — PURVEYORS OF PLASMA SCREENS TO THE GENTRY

Merry Christmas
To All Our Friends
In Aston Abbotts



& A Happy New Year
Alison & Dave Lewis

FLACKWELL ELECTRONICS

AVIONICS SPECIALISTS
Prop. David Lewis
(Established 60 years)

We also repair TV, DVD and electrical appliances
01296 682126
www.flackwellelectronics.co.uk

ASTON ABBOTTS

WATCHTOWER



Dave Lewis is a Barsole

What, you may ask is a "Barsole"? Well... we at The Chronicle would like to know the answer to that as well?

Should you happen across Dave's conscience then we suggest you as her what a "barsole" is, as it is apparently she who coined the term whilst holidaying in Edinburgh over the New Year.

In the meantime, we think it would be rather nice to use this new form of address when greeting Dave. In future instead of yelling "Hello Dave!" or just "Lewis!", please shout, "Hello you old Barsole."

Man Flu – The Facts...

1. Man-Flu is more painful than childbirth. This is an irrefutable scientific fact*.
*(Based on a survey of over 100,000 men.)
2. Man-Flu is not 'just a cold'. It is a condition so severe that the germs from a single Man-Flu sneeze could wipe out entire tribes of people living in the rainforest. And probably loads of monkeys too.
3. Women do not contract Man-Flu. At worst they suffer from what is medically recognised as a 'Mild Girly Sniffle' – which, if a man caught, he would still be able to run, throw a ball, tear the phone book in half and compete in all other kinds of manly activities.
4. Men do not 'moan' when they have Man-Flu. They emit involuntary groans of agony that are entirely in proportion to the unbearable pain they are in.
5. Full recovery from Man-Flu will take place much quicker if their simple requests for care, sympathy and regular cups of tea are met. Is that really so much to ask?
6. More men die each year from MFN (Man-Flu Neglect) than lots and lots of other things. (Like rabbit attacks or choking on toast).
7. Men suffering from Man-Flu want nothing more than to get out of bed and come to work, but they are too selfless to risk spreading this awful condition amongst their friends and colleagues. In this sense, they are the greatest heroes this country has ever known.
8. In 1982 scientists managed to simulate the agonising symptoms of full blown Man-Flu in a female chimp. She became so ill that her head literally fell off.
9. Man-Flu germs are more powerful than Iron Man, Superman and Captain America combined. They are too strong for weak, nasty tasting 'lady medicines' like Lemsip, so don't bother trying to force them on a victim of Man-Flu.
10. While it may seem like a Man-Flu sufferer is just lying around enjoying *Baywatch* re-runs it is a commonly recognised medical fact that the exact pitch and frequency of Pamela Anderson's voice has remarkable soothing powers.

Every minute in this country one man is struck down by Man-Flu. Women, all we ask is that each of you offers them a cup of tea, some kind words and your undivided attention and care. Then maybe, just maybe, we'll beat this monstrous disease together...

FLACKWELL ELECTRONICS — PURVEYORS OF PLASMA SCREENS TO THE GENTRY

FLACKWELL ELECTRONICS

AVIONICS SPECIALISTS

**Prop. David Lewis
(Established 60 years)**

**We also repair TV, DVD and
electrical appliances**

01296 682126

www.flackwellelectronics.co.uk

ASTON ABBOTTS

WATCHTOWER

Epic Fail

The only Welshman in the village announced an alcohol-free January. He stuck to his guns... and we were impressed.

Then one Saturday at 6.30 Club he was proudly boasting that he had achieved it as he scoffed down a pint of Guinness. Except... there are 31 days in January Neil, not 30, and it was Saturday the 31st.

Failure!!! Sorry - do it again please Neil.

Dave's Apology

So Dave went in to the pub to apologise. Nothing unusual there, you say.

But wait! Normally Dave is sent to apologise when he cannot remember what he has done wrong. This time he remembered, he apologised, but nobody else knew what he had done, least of all the person to whom he was apologising. Very Strange!

Got it Covered

Charged with the task of producing a cover picture for The Chronicle yours truly grabbed his Instamatic and headed off into the garden one frosty morning.

Casting my eye around for inspiration a frost laden bloom caught my eye. Everything was right, with the angle of the sun causing the frost to effervesce over the dark red plant which stood out in sharp relief against the background.

Later, I proudly showed the perfect picture to my wife.

Forty-one years of blissful togetherness helped me instinctively realise that the hotly anticipated approbation was not going to be forthcoming.

"What's wrong?" I asked

"That's a *plastic* flower!" she said.

Well how was I supposed to know that plant wouldn't bloom in January? We can't all be Vic or Christine Scott you know!

Piste Off

Even the most experienced of skiers will have an accident some time. For some, coming home with strapping and bandages are a badge of honour - a sign of the extremes to which they will push themselves in the pursuit of sporting perfection.

But surely it's just a little bit embarrassing to have to admit the injury was caused not by a bad landing from a 200m ski jump, but by falling down the stairs at the ski resort!

Oh dear! We hope you get better soon Karen!

Quote of the Month

Dave Lewis: "Very little upsets me....."

In the Picture

Wow! So Stuart got to sit just six seats away from Bob Geldof at the recent Elbow gig in London.

But did Stuart really photo-bomb Bob's selfie???

FLACKWELL ELECTRONICS — PURVEYORS OF PLASMA SCREENS TO THE GENTRY

FLACKWELL ELECTRONICS

AVIONICS SPECIALISTS
Prop. David Lewis
(Established 60 years)

We also repair TV, DVD and electrical appliances
01296 682126
www.flackwellelectronics.co.uk

ASTON ABBOTTS

WATCHTOWER

Dirty Pictures

Ever wondered what those Gnomes get up to? We hear that a senior Gnome has been sneaking off to 18-rated movies with her friends. Yes, Queen Gnome went to see 50 Shades of Grey. She didn't pick up any useful tips though - just looking bewildered later that evening when she spotted the roll of Duct Tape her hopeful husband had left on her pillow.

It appears she is not the only one going to the movies for titillation - we also heard that the Welshman from Nash's Farm went to see Shaun the Sheep...

Easily Bought?

I realise that political comment has no place in The Chronicle, but last Friday at the Royal Oak I couldn't help celebrating my evening's saving of four whole pence, thanks to the penny off a pint budget 'giveaway'.

Yeah... That's sure bought my vote George...

Fat B*****!

Spare a thought for a certain former Chronicle editor. One March morning he stood on his bathroom scales, as per his normal daily routine. This time there was a loud cracking noise, the scales readout displayed "Error", and they never worked again.

He claims the scales were ten years old and the plastic must have become brittle, but we think there is a message in there somewhere Phil...



Sunshine (1)

You will rarely hear Dave Lewis admit he that needs glasses, but he has let slip that he has pairs all over the place—just for small print you understand. And we have heard that a former policeman from Aston Abbots also has several pairs of glasses stashed around the house. He even admits to having a pair stashed in his windowless toilet - and they are *sunglasses*!

So just where do you think that sun is shining from in your toilet then Jeff??



Sunshine (2)

So does Bob Bean hold the record for being the first person this year to be out on his sunbed?

We are not surprised at Bob being first to sunbathe in March, just surprised that he did it on the day of the eclipse!

FLACKWELL ELECTRONICS — PURVEYORS OF PLASMA SCREENS TO THE GENTRY

FLACKWELL ELECTRONICS

AVIONICS SPECIALISTS

**Prop. David Lewis
(Established 60 years)**

**We also repair TV, DVD and
electrical appliances**

01296 682126

www.flackwellelectronics.co.uk

ASTON ABBOTTS

WATCHTOWER

Air Quality

Your scribe's wife came home from work recently to find me sprawled out languishing in the garden. I pointed out that local radio station *Mix96* had been giving out warnings that older people should not exert themselves due to current poor air quality, so I was being careful. She said she hadn't noticed me doing anything different. She can be so cruel...

Warning

If Dave Lewis tries to pay you with brand new £10 or £20 notes - just say no!!!

John Whyte

Burglar Alarm Installer

New systems expertly installed in a mere seven hours.

Free advice: We will send our assistant around to help choose where to place the siren/beacon box - preferably around the corner down the side of the house where that nasty flashy light thingy does not affect the aesthetics of the building and the horrible shrill squeaky thing does not disturb anybody.



Sore Bum



Being fed up with saddle sores from his hi-tech road bike Dave Lewis has purchased a new Mountain Bike. Apparently the 27-speed gears and suspension makes for a much more comfortable ride. Dave says the new bike is just like himself - built for comfort and not for speed.

Fancy That?

Our Glorious Leader caused a raised eyebrow recently. But it wasn't because he admitted to watching *Poldark*...

No... Our Glorious Leader confessed that he found Ross Poldark more attractive than Demelza or Elisabeth! OK... each to his own...

FLACKWELL ELECTRONICS — FREE DELIVERY OF EVERYTHING TO THE GENTRY

FLACKWELL ELECTRONICS

AVIONICS SPECIALISTS
Prop. David Lewis
(Established 60 years)

We also repair TV, DVD and electrical appliances
01296 682126
www.flackwellelectronics.co.uk

ASTON ABBOTTS

WATCHTOWER

Corsican Sticky Toffee Sausages

We bring you a brand new recipe, courtesy of Aston Abbotts' own Spanish chef Juan Gutiérrez.

Ingredients

- One kilo of Corsican sausages
- One third of a bottle of Peter Shorrock's very best sweet Corsican desert wine

Method

- Place the ingredients in Peter Shorrock's best non-stick pan
- Fry until everything has gone black
- Prior to serving, ensure all sugar in the wine is converted to dangerous carcinogens

To serve

- Carefully prise the sausages free from the sticky black glutinous mess in the pan
- Serve accompanied with life-threatening quantities of white bread and cheese

Warning

- Carefully dispose of the now-unusable non-stick pan in the hazardous waste section of the local tip

Did You Hear ...

Did you hear the one about 6 Aston Abbotts blokes who went into a Corsican supermarket to buy bread? Within two minutes their trolley was filled with 15 bottles of wine, 26 bottles of beer, 11 different cheeses and one pack of octopus in oil and herbs
It's a true story!

Religion

Many people may be stunned to hear that on the recent Aston Abbotts cultural excursion to Corsica John Whyte was spotted inside a church not once, but **twice!**
However, we wish to reassure you that the Red Sea was not parted, no Damascene conversion has taken place, and God still does not believe in John Whyte.

(Old) Men Behaving Badly

The guys from Aston Abbotts decided to grow beards whilst in Corsica. Of course there are many different types of beard. For example:

The Goatee

- Style: Small beard surrounding the mouth and chin
- Maintenance: Keep cheeks clean shaven

The Curtain

- Style: Hangs from the lower chin only
- Maintenance: Keep cheeks and upper lip clean shaven

...and now...

The Corsican Stubble

- Style: Short and grey
- Maintenance: Forcibly removed by angry spouse upon arrival home.



FLACKWELL ELECTRONICS — FREE DELIVERY OF EVERYTHING TO THE GENTRY

FLACKWELL ELECTRONICS

OF CHURCH FARM, ASTON ABBOTTS

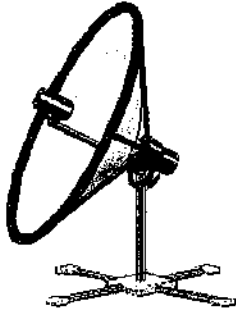

- PLASMA
- LCD
- DVD
- HDTV

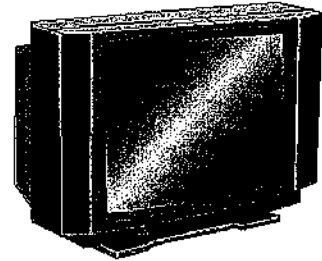

**AVIATION
HEADSET
REPAIR**

**01296
682126**



**01296
682126**



**KEEP
CALM**

Normal service

**Will resume
Shortly**

**OUR BACK PAGE
REPORTERS AND THEIR
VICTIMS HAVE ALL BEEN
ON HOLIDAY. DON'T
WORRY - NORMAL
SERVICE WILL BE
RESUMED WHEN
KINDERGARTEN RESTARTS
IN THE AUTUMN**

**Has Anybody Seen Jack
Ryan?**

Jack Ryan was visiting the village and was left in the company of Neil Chesher... in the pub (obviously a very bad move). He hasn't been seen since.

There has been a rumoured sighting of him on the windowsill of a house in Bricstock. Please contact The Chronicle if you have information on his whereabouts.

FLACKWELL ELECTRONICS — PURVEYORS OF PLASMA SCREENS TO THE GENTRY

FLACKWELL ELECTRONICS

OF CHURCH FARM, ASTON ABBOTTS

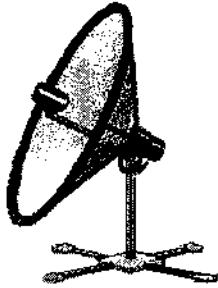

- ~ PLASMA
- ~ LCD
- ~ DVD
- ~ HDTV

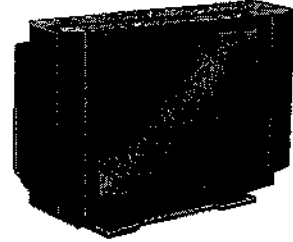

**AVIATION
HEADSET
REPAIR**

**01296
682126**



**01296
682126**

Jokes from the Edinburgh Fringe

"I just deleted all the German names off my phone. It's Hans free" ~ *Darren Walsh*

"Surely every car is a people carrier?" ~ *Adam Hess*

"What's the difference between a 'hippo' and a 'Zippo'? One is really heavy, the other is a little lighter" ~ *Masai Graham*

"If I could take just one thing to a desert island I probably wouldn't go" ~ *Dave Green*

"Jesus fed 5,000 people with two fishes and a loaf of bread. That's not a miracle. That's tapas" ~ *Mark Nelson*

"Red sky at night. Shepherd's delight. Blue sky at night. Day" ~ *Tom Parry*

"Kim Kardashian is saddled with a huge bum... but enough about Kanye West" ~ *Stewart Francis*

"The first time I met my wife, I knew she was a keeper. She was wearing massive gloves" ~ *Alan Cochrane*

"Clowns divorce. Custardy battle" ~ *Simon Munnery*

"They're always telling me to live my dreams. But I don't want to be naked in an exam I haven't revised for..." ~ *Grace The Child*

"I never lie on my CV, because it creases it." ~ *Jenny Collier*

"If you don't know what introspection is you need to take a long, hard look at yourself" ~ *Ian Smith*

"I usually meet my girlfriend at 12:59 because I like that one-to-one time" ~ *Tom Ward*

"Whenever I get to Edinburgh, I'm reminded of the definition of a gentleman. It's someone who knows how to play the bagpipes, but doesn't" ~ *Gyles Brandreth*

"Let me tell you a little about myself. It's a reflexive pronoun that means 'me'" ~ *Ally Houston*

"Earlier this year I saw 'The Theory of Everything' - loved it. Should've been called 'Look Who's Hawking', that's my only criticism" ~ *James Acaster*

Tesco Advice

When visiting Tesco in an expensive Alfa Romeo loan car, please:

- 1) Avoid the entrance posts.
- 2) Make sure you have comprehensive insurance.

Thank you.

FLACKWELL ELECTRONICS — PURVEYORS OF PLASMA SCREENS TO THE GENTRY

FLACKWELL ELECTRONICS

OF CHURCH FARM, ASTON ABBOTTS

PLASMA – LCD – DVD – HDTV

SPECIALISTS IN AVIATION HEADSET REPAIRS

01296 682126

flackwellelectronics@unibox.com



Dave Lewis interviewing for cabin staff for his new budget airline.

FLACKWELL ELECTRONICS – PURVEYORS OF PLASMA SCREENS TO THE GENTRY

01296 682126 — FLACKWELL ELECTRONICS — 01296 682126

HALLOWEEN AT THE ROYAL OAK

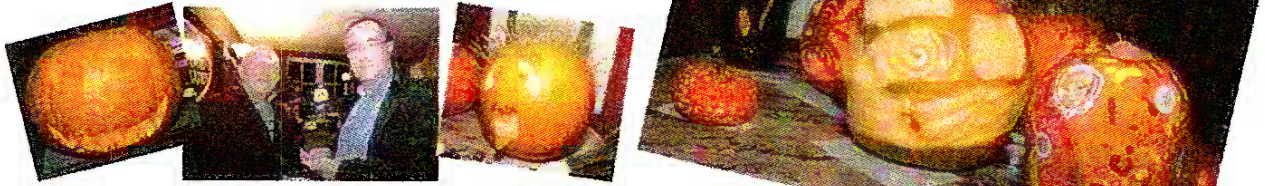

FLACKWELL ELECTRONICS — PURVEYORS OF PLASMA SCREENS TO THE GENTRY

FLACKWELL ELECTRONICS



Alison and Dave

wish all of their friends in

Aston Abbots a very

Merry Christmas

and a

Happy New Year

FLACKWELL ELECTRONICS — PURVEYORS OF PLASMA SCREENS TO THE GENTRY

FLACKWELL ELECTRONICS

CHURCH FARM, ASTON ABBOTTS



- ~ PLASMA
- ~ LCD
- ~ DVD
- ~ HDTV

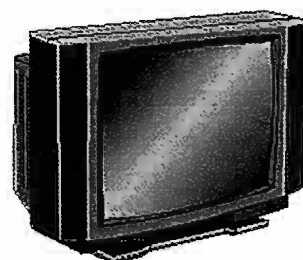

**AVIATION
HEADSET
REPAIR**

**01296
682126**



**01296
682126**

NEW YEAR TALES

A married couple had been out shopping in the New Year sales for most of the day. Suddenly the wife realised that her husband had “disappeared”. Somewhat irate she called her husband’s mobile and demanded, ‘Where are you?’

Husband: ‘Darling, do you remember that little jewellery shop where you saw that beautiful diamond necklace and totally fell in love with it but I didn’t have the money at that time and I said “Darling it’ll be yours one day.”’

Wife, tremulously, ‘Yes, I do remember that my love.’

Husband, ‘Well I’m in the Pub next to that shop.’

An optimist stays up until midnight to see the new year in. A pessimist stays up to make sure the old year leaves.

~ *Bill Vaughan*

A new years resolution is something that goes in one year and out the other.

May all your troubles last as long as your New Year’s resolutions.

I'm on a wine diet. I've lost three days already!



FLACKWELL ELECTRONICS — PURVEYORS OF PLASMA SCREENS TO THE GENTRY

FLACKWELL ELECTRONICS

CHURCH FARM, ASTON ABBOTTS



- ~ PLASMA
- ~ LCD
- ~ DVD
- ~ HDTV

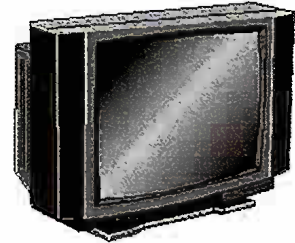

**AVIATION
HEADSET
REPAIR**

**01296
682126**



**01296
682126**

VILLAGE HALL BURNS FUNDRAISER



FLACKWELL ELECTRONICS — PURVEYORS OF PLASMA SCREENS TO THE GENTRY

FLACKWELL ELECTRONICS

CHURCH FARM, ASTON ABBOTTS

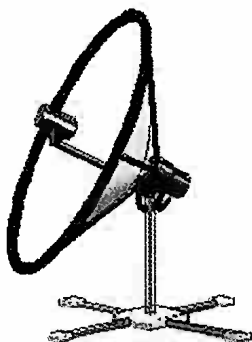

- ~ PLASMA
- ~ LCD
- ~ DVD
- ~ HDTV

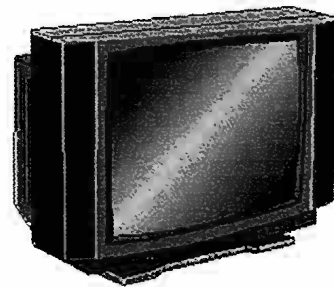

**AVIATION
HEADSET
REPAIR**

**01296
682126**



**01296
682126**

A recent study has found that women who carry a little extra weight live longer than the men who mention it.

Just read that 4,153,237 people got married last year. Not to cause any trouble, but shouldn't that be an even number?

Thanks for explaining the word "many" to me, it means a lot.

There are three kinds of people: Those who can count and those who can't.

Have you heard about the evil group of men who control all the world's cheese? The hallouminati

I was given some Sudoku toilet paper. It didn't work. You could only fill it in with number 1s and number 2s

I used to think an ocean of soda existed, but it was just a Fanta sea

I bought a vacuum cleaner six months ago and so far all it's been doing is gathering dust.

I wasn't originally going to get a brain transplant, but then I changed my mind.

A fine is a tax for doing wrong. A tax is a fine for doing well.

I'm reading a book about anti-gravity. It's impossible to put down.

I like birthdays, but I think too many can kill you.

When wearing a bikini, women reveal 90 % of their body... men are so polite they only look at the covered parts.

Hospitality: making your guests feel like they're at home, even if you wish they were.

Politicians and nappies have one thing in common. They should both be changed regularly, and for the same reason.

Nothing is fool proof to a sufficiently talented fool.



FLACKWELL ELECTRONICS — PURVEYORS OF PLASMA SCREENS TO THE GENTRY

FLACKWELL ELECTRONICS

CHURCH FARM, ASTON ABBOTTS

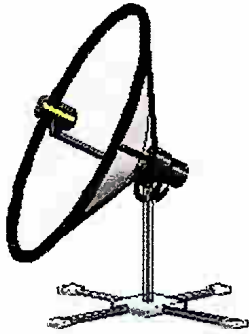

- ~ **PLASMA**
- ~ **LCD**
- ~ **DVD**
- ~ **HDTV**



**AVIATION
HEADSET
REPAIR**

**01296
682126**



**01296
682126**

ANNUAL PARISH MEETING

WEDNESDAY 13th APRIL — 8PM IN THE VILLAGE HALL

Public Meeting — Everybody welcome

Hear what is happening in Aston Abbots

Have your say — Raise any issues that concern you

Agenda and last year's minutes online at www.aston-abbotts.co.uk/pcdocuments.htm

Are you signed up to the

Aston Abbots Postbox

Get up to date email notices relevant to Aston Abbots

Spam free—submit your own notices or adverts

To join, just send an email to

postbox@aston-abbotts.co.uk



FLACKWELL ELECTRONICS — PURVEYORS OF PLASMA SCREENS TO THE GENTRY

FLACKWELL ELECTRONICS

CHURCH FARM, ASTON ABBOTTS

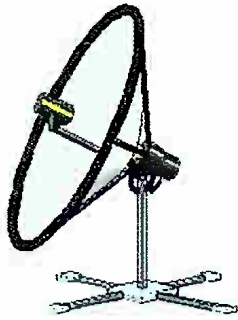

- ~ PLASMA
- ~ LCD
- ~ DVD
- ~ HDTV

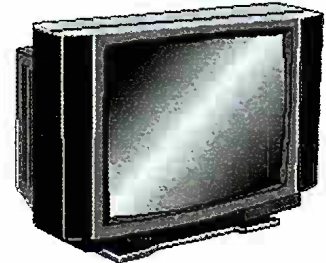

**AVIATION
HEADSET
REPAIR**

**01296
682126**



**01296
682126**

MODS ARE BACK!

For the first time since the 1960s the Mods are back in Aston Abbotts!

The picture on the right shows the first Mod arrival posing with his gleaming new Vespa scooter.

Is Aston Abbotts about to be beset by rampant hordes of marauding septuagenarian Mods racing up and down Moat Lane, posing and preening outside The Royal Oak, and terrifying pensioners at the Thursday Coffee Mornings?

Whatever next in Aston Abbotts?



FLACKWELL ELECTRONICS — PURVEYORS OF PLASMA SCREENS TO THE GENTRY

FLACKWELL ELECTRONICS

CHURCH FARM, ASTON ABBOTTS



- ~ **PLASMA**
- ~ **LCD**
- ~ **DVD**
- ~ **HDTV**

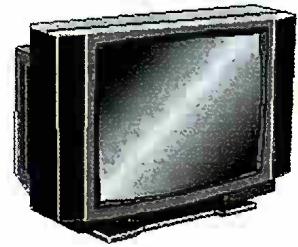

**AVIATION
HEADSET
REPAIR**

**01296
682126**



**01296
682126**



Aston Abbots residents will be used to Dave Lewis' antics, but taking your mask and respirator off 100 feet down in the Mediterranean is crazy even by Dave's standards. Dave wanted us to see that it was him sitting in the cockpit of the wrecked B17 bomber. But we would know it is you Dave—nobody else is fool enough!!! Juan Gutierrez looks on. Now ask Dave about his souvenir!

FLACKWELL ELECTRONICS — PURVEYORS OF PLASMA SCREENS TO THE GENTRY

FLACKWELL ELECTRONICS

CHURCH FARM, ASTON ABBOTTS

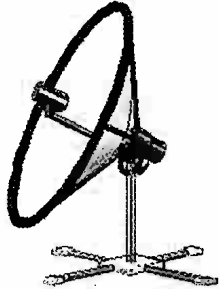

- ~ PLASMA
- ~ LCD
- ~ DVD
- ~ HDTV

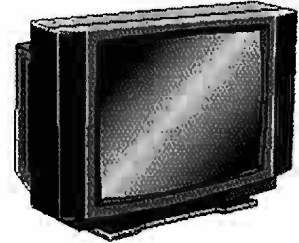

**AVIATION
HEADSET
REPAIR**

**01296
682126**



**01296
682126**

So much for flaming June !!!

Q: What do you call it when it rains chickens and ducks?

A: Foul weather.

Q: What did one raindrop say to the other?

A: Two's company, three's a cloud

Q: What goes up when the rain comes down?

A: An Umbrella.

Q: What do you call two straight days of rain in Aston Abbotts?

A: A weekend.

It rains only twice a year in Aston Abbotts. August to April and May to July.

Q: What do you call a months worth of rain?

A: England

Red sky at night, shepherd's delight. Blue sky at night, day.

Q: What do you call dangerous precipitation?

A: A rain of terror.

Everyone talks about the weather, but no one does anything about it. (Mark Twain)

Q: What did the lightning bolt say to the other lightning bolt?

A: You're shocking!

Q: What happens when it rains cats and dogs?

A: You have to be careful not to step in a poodle.

Q: What is the opposite of a cold front?

A: A warm back

But who wants to be foretold the weather? It is bad enough when it comes, without our having the misery of knowing about it beforehand. (Jerome K. Jerome)

FLACKWELL ELECTRONICS — PURVEYORS OF PLASMA SCREENS TO THE GENTRY

FLACKWELL ELECTRONICS

CHURCH FARM, ASTON ABBOTTS



- ~ PLASMA
- ~ LCD
- ~ DVD
- ~ HDTV

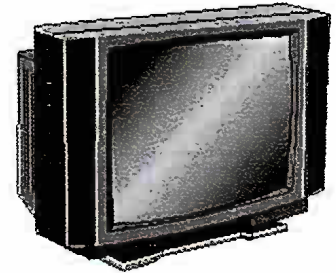

**AVIATION
HEADSET
REPAIR**

**01296
682126**



**01296
682126**

*Congratulations to Dave
and Alison on their 30th
Wedding Anniversary*

Happy
Anniversary



When a newly married man looks happy we know why. But when a thirty-year married man looks happy - we wonder why?

Spouse: someone who'll stand by you through all the trouble you wouldn't have had if you'd stayed single.

A perfect wife is one who helps the husband with the dishes.

When a married man says "I'll think

about it", What he really means is that he doesn't know his wife's opinion yet..

Dave is boasting to his mates that he's taking his wife to Italy for their 30th wedding anniversary.

"Well, what will you do for your 40th?" Whytey asks.

Dave: "I'll go and fetch her back."

A good wife always forgives her husband when she's wrong.—Milton Berle

FLACKWELL ELECTRONICS — PURVEYORS OF PLASMA SCREENS TO THE GENTRY

FLACKWELL ELECTRONICS

CHURCH FARM, ASTON ABBOTTS



- ~ PLASMA
- ~ LCD
- ~ DVD
- ~ HDTV



**AVIATION
HEADSET
REPAIR**

**01296
682126**



**01296
682126**

FAT B*****

Villagers who know Dave Lewis cannot fail to have noticed his massive loss of weight over the last year or two. That's been made even more obvious by his investment in a new wardrobe of skinny jeans and other skinny clothes.

However, four months of non-stop holidays and partying over the summer have taken their toll and piled on the pounds. Imagine Dave's distress on his final holiday; taking out his new skinny suit for a smart night out only to find he couldn't do the trousers up! He had to borrow a pair!!!

Face it Dave—you're just a fat b*****.

~ by A. Fatterbusted

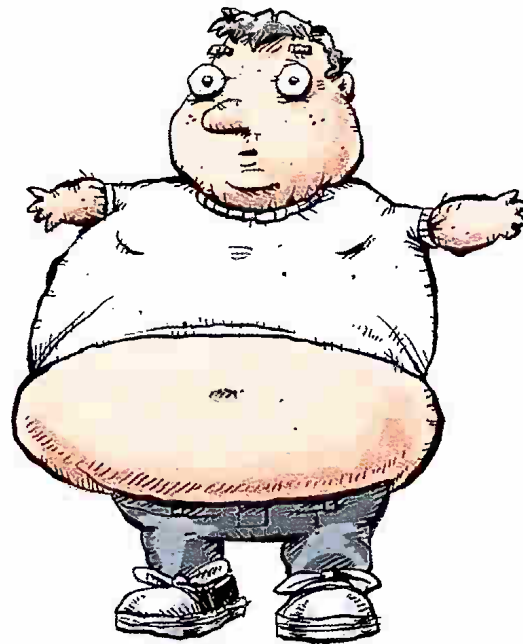

Dave—after holidays!

FLACKWELL ELECTRONICS — PURVEYORS OF PLASMA SCREENS TO THE GENTRY

Playgirl

THE
**SENIOR
ISSUE!**

NOVEMBER PLAYMATE
DAVID W LEWIS

GLAD TO BE GREY

LOSE WITH LEWIS
WEIGHT LOSS PLAN

SEX AFTER 60
HOW TO BEG

PLAYGIRL UK
NOVEMBER

£2.99

9 772046 376005 05

01296 682126 ~ FLACKWELL ELECTRONICS ~ 01296 682126

*Alison & Dave
Wish Everyone
A Merry Christmas
and a Happy New Year*

